



CHUCK

Large Thru-Hole High Speed Power Chuck B-200 series

World Renowned Standard chuck

* CE correspondence



Dimensional Drawings

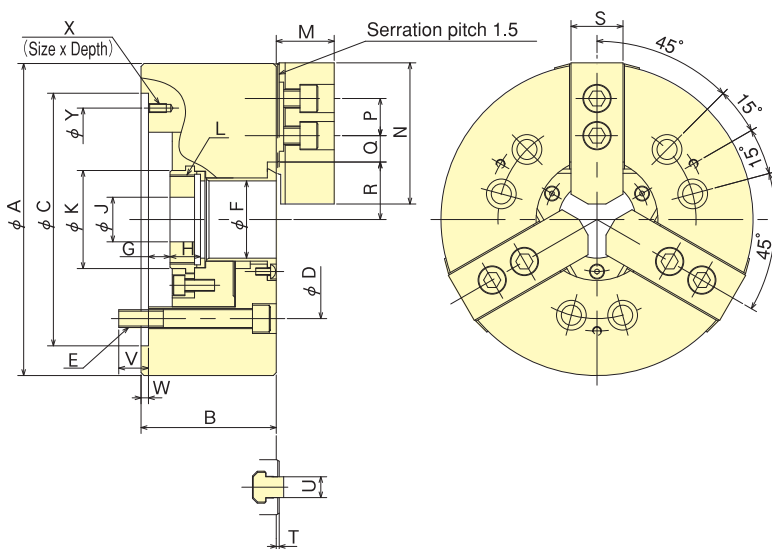

Gripping Example

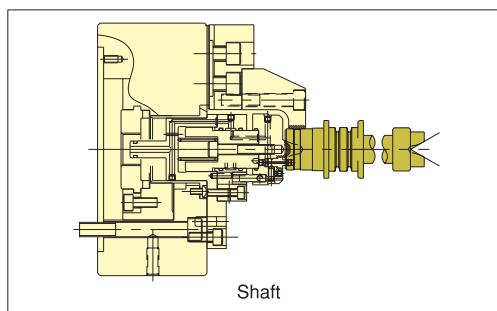

Gripping Characteristic Graphs

*With standard blank soft top jaw.

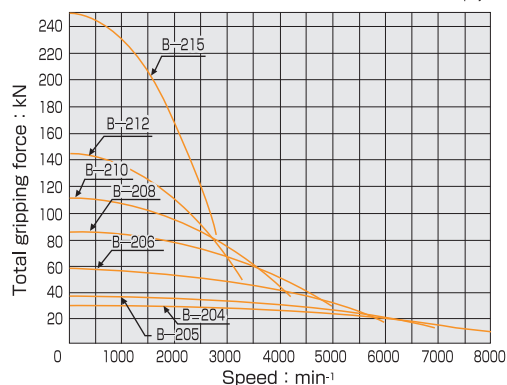

Dimensions

*Mounting Bolt P. C. D for B-204 & B-205 : 120° Pitch : 3pcs. *Blank draw nut equipped.

Model	A	B	C (H6)	D	E	F	G max.	G min.	H	J	K	L max.	M	N	P	Q max.	Q min.	R max.	R min.	S	T	U	V	W	X (3-)	Y
B-204	110	59	85	70.6	3-M10	26	3.5	- 6.5	17.5	12	38	M32x1.5	24	49.5	14	11.25	6.75	23	20.3	23	2	10	15.5	4	-	-
B-205	135	60	110	82.6	3-M10	33	1	- 9	20	12	45	M40x1.5	26	54	14	19.75	7.75	26.5	23.8	23	2	10	15	4	-	-
B-206	169	81	140	104.8	6-M10	45	11	- 1	19	20	60	M55x2	29	66	20	22.75	9.25	32	29.25	26	2	12	16	5	M6x10	116
B-208	210	91	170	133.4	6-M12	52	14.5	- 1.5	20.5	30	66	M60x2	39	95	25	29.75	14.75	38.7	35	35	2	14	20	5	M6x12	150
B-210	254	100	220	171.4	6-M16	75	8.5	-10.5	25	45	94	M85x2	43	110	30	33.75	14.25	51	46.6	40	2	16	22	5	M8x15	190
B-212	304	110	220	171.4	6-M16	91	8	-15	28	50	108	M100x2	51	111	30	45.75	15.75	61.3	56	50	2	21	23	6	M8x15	190
B-215	381	147	300	235	6-M20	100	23	0	35	50	120	M110x2	61	135	43	54.75	20.25	70	64.7	50	2	25.5	31	6	M10x16	260

Specifications

*Max. speed is shown using actual test data.

Model	Thru-Hole mm	Gripping range mm Max. Min.	Jaw Stroke (diameter) mm	Plunger Stroke mm	Max. Draw Bar Pull Force kN (kgf)	Max. Gripping Force kN (kgf)	Max. Speed min⁻¹	Net Weight with Soft top jaws kg	Moment of Inertia kg·m²	Matching Cylinder	Max. pressure MPa(kgf/cm²)	Matching Hard top jaw	Matching Soft top jaw
B-204	26	110 7	5.4	10	14 (1428)	285 (2906)	8000	4.0	0.007	F0933H	2.80 (28.6)	HB04N1	SB04N1
B-205	33	135 12	5.4	10	17.5 (1784)	36 (3671)	7000	6.7	0.018	F0933H	3.43 (35.0)	HB04N1	SB05N1
B-206	45	169 16	5.5	12	22 (2243)	57 (5812)	6000	11.9	0.058	S1246	2.8 (28.6)	HB06B1	SB06L1A
B-208	52	210 13	7.4	16	34.8 (3549)	86 (8769)	5000	22.3	0.170	S1552	2.65 (27)	HB08A1	SB08B1
B-210	75	254 31	8.8	19	43 (4385)	111 (11319)	4200	34.5	0.315	S1875	2.70 (27.5)	HB10A1	SB10B1
B-212	91	304 34	10.6	23	55 (5608)	144 (14684)	3300	55.3	0.738	S2091	2.70 (27.5)	HB12N1	SB12N1
B-215	100	381 50	10.6	23	98 (9933)	249 (25391)	2800	116.0	2.20	F2511H	3.30 (33.7)	HB15N1	SB15N1



CHUCK

Large Thru-Hole High Speed Power Chuck (Direct Mount) B-200A series

Equipped with Chuck Adaptor to suit Spindle Nose
Universally recognised standard chuck

* CE correspondence

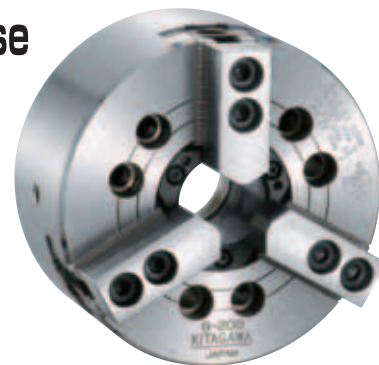

Dimensional Drawings

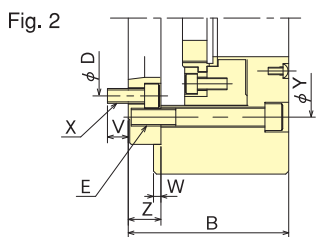
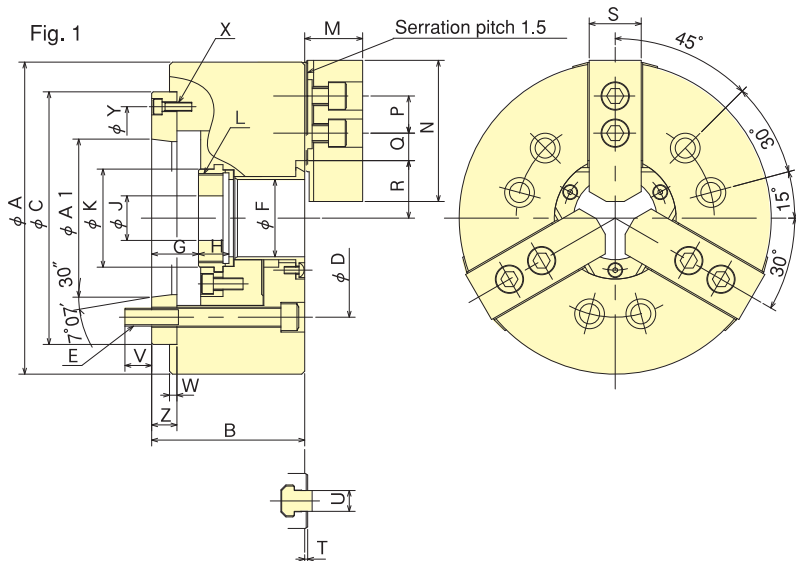

Dimensions

*B-210A6, B-212A6 are referred to in Fig.2. *Blank draw nut equipped.

Dimensions Model	A	B	C	D	E	F	G max.	G min.	H	J	K	L max.	M	N	P	Q max.	Q min.	R max.	R min.	S	T	U	V	W	X	Y	Z	A1
B-206A5	169	91	140	104.8	6-M10	45	26	14	19	20	60	M55x2	29	66	20	22.75	9.25	32	29.25	26	2	12	16	5	3-M 6	116	15	82.563
B-208A6	210	103	170	133.4	6-M12	52	31.5	15.5	20.5	30	66	M60x2	39	95	25	29.75	14.75	38.7	35	35	2	14	18	5	3-M 6	150	17	106.375
B-210A6	254	120	220	133.4	6-M16	75	33.5	14.5	25	45	94	M85x2	43	110	30	33.75	14.25	51	46.6	40	2	16	18.5	5	6-M12	171.4	25	106.375
B-210A8	254	113	220	171.4	6-M16	75	26.5	7.5	25	45	94	M85x2	43	110	30	33.75	14.25	51	46.6	40	2	16	24	5	3-M 8	190	18	139.719
B-212A6	304	129	220	133.4	6-M16	91	33	10	28	50	108	M90x2	51	111	30	45.75	15.75	61.3	56	50	2	21	18.5	6	6-M12	171.4	25	106.375
B-212A8	304	122	220	171.4	6-M16	91	26	3	28	50	108	M100x2	51	111	30	45.75	15.75	61.3	56	50	2	21	25	6	3-M 8	190	18	139.719

Specifications

*Max. speed is shown using actual test data.

Specifications Model	Thru-Hole mm	Gripping range mm Max. Min.	Jaw Stroke (diameter) mm	Plunger Stroke mm	Max. Draw Bar Pull Force kN (kgf)	Max. Gripping Force kN (kgf)	Max. Speed min ⁻¹	Net Weight with Soft top jaws kg	Moment of inertia kg·m ²	Matching Cylinder	Max. pressure MPa(kgf/cm ²)	Matching Hard top jaw	Matching Soft top jaw	Spindle nose size
B-206A5	45	169 16	5.5	12	22 (2243)	57 (5812)	6000	13.7	0.063	S1246	2.8 (28.6)	HB06B1	SB06L1A	A2-5
B-208A6	52	210 13	7.4	16	34.8(3549)	86 (8769)	5000	23.6	0.178	S1552	2.65(27)	HB08A1	SB08B1	A2-6
B-210A6	75	254 31	8.8	19	43 (4385)	111(11319)	4200	41.5	0.325	S1875	2.7 (27.5)	HB10A1	SB10B1	A2-6
B-210A8	75	254 31	8.8	19	43 (4385)	111(11319)	4200	40.0	0.323	S1875	2.7 (27.5)	HB10A1	SB10B1	A2-8
B-212A6	91	304 34	10.6	23	55 (5608)	144(14684)	3300	67	0.780	S2091	2.7 (27.5)	HB12N1	SB12N1	A2-6
B-212A8	91	304 34	10.6	23	55 (5608)	144(14684)	3300	64	0.765	S2091	2.7 (27.5)	HB12N1	SB12N1	A2-8

Standard Chuck

Gripping Example

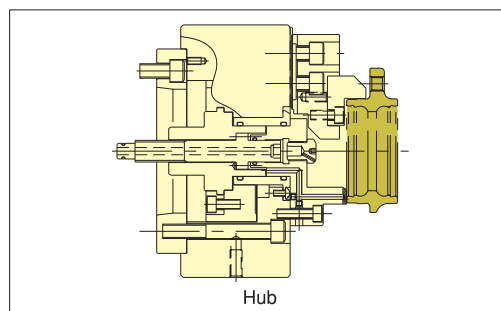

Gripping Characteristic Graphs

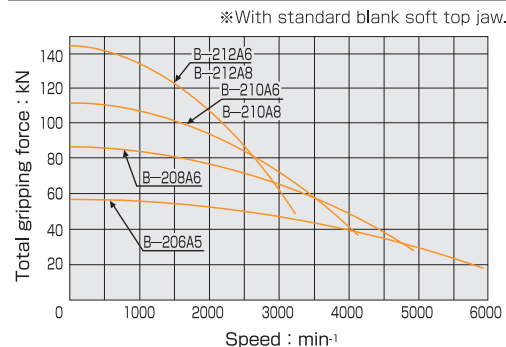



CHUCK

Large Thru-Hole Power Chuck

B series

Stable Machining for Large Work Pieces
Universally recognised standard chuck

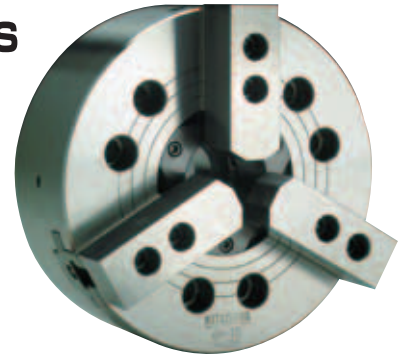

● **Through-hole**

15inch ϕ 117.5 · 18inch ϕ 117.5
 21inch ϕ 140.0 · 24inch ϕ 165.0

* CE correspondence

■ **Dimensional Drawings**

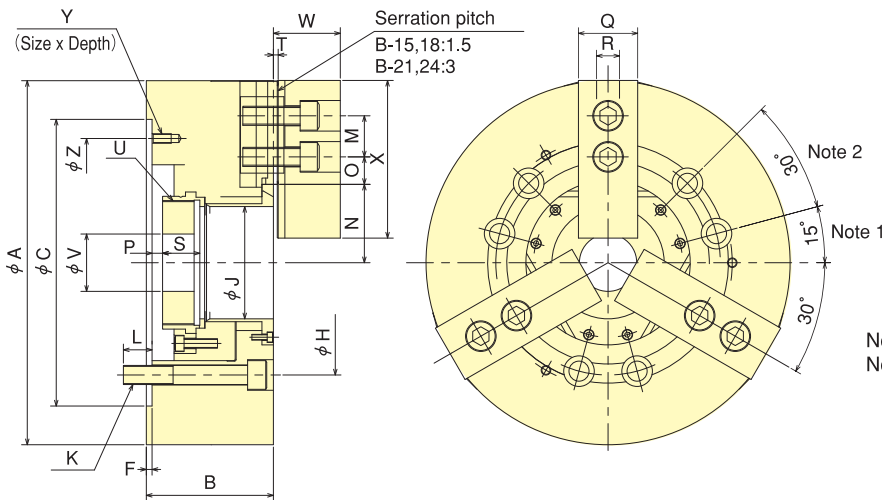

Gripping Characteristic Graphs

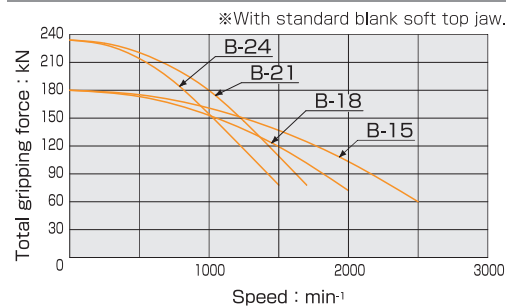

■ **Dimensions** ※Blank draw nut equipped.

Dimensions Model	A	B	C (H6)	F	H	J	K	L	M	N max.	N min.	O max.	O min.	P max.	P min.	Q	R	S	T	U max.	V	W	X	Y	Z
B-15	381	133	300	6	235	117.5	6-M20	30	43	82	76.7	43.75	18.25	11	-12	62	22	39	5	M130x2	60	70	165	M10x20	260
B-18	450	133	380	6	235	117.5	6-M20	30	43	82	76.7	78.25	18.25	11	-12	62	22	39	5	M130x2	60	70	165	M10x20	320
B-21	530	140	380	6	330.2	140	6-M22	31	60	98.5	93.2	87.5	21.5	11	-12	65	25	39	5	M155x3	80	73	180	M12x30	330.2
B-24	610	149	380	6	330.2	165	6-M22	32	60	108	102.7	117.5	21.5	20	-3	65	25	40.5	5	M175x3	80	73	180	M12x25	330.2

■ **Specifications**

Specifications Model	Thru-Hole mm	Gripping range mm Max.	Gripping range mm Min.	Jaw Stroke (diameter) mm	Plunger Stroke mm	Max. Draw Bar Pull Force kN (kgf)	Max. Gripping Force kN (kgf)	Max. Speed min ⁻¹	Net Weight with Soft top jaws kg	Moment of Inertia kg·m ²	Matching Cylinder	Max. pressure MPa(kgf/cm ²)	Matching Hard top jaw	Matching Soft top jaw
B-15	117.5	381	30	10.6	23	71(7240)	180(18355)	2500	120	2.273	F2511H	2.3(23.5)	HB15A1	SB15C1
B-18	117.5	450	30	10.6	23	71(7240)	180(18355)	2000	164	4.451	F2511H	2.3(23.5)	HB15A1	SB15C1
B-21	140	530	87	10.6	23	90(9177)	234(23861)	1700	235	8.95	F2511H	3.0(30.6)	HB18B2	SB18A2
B-24	165	610	109	10.6	23	90(9177)	234(23861)	1400	293	16.60	F2511H	3.0(30.6)	HB18B2	SB18A2



CHUCK

Large Thru-Hole Power Chuck (Direct Mount) B-A series

Equipped with Chuck Adaptor to suit Spindle Nose
Universally recognised standard chuck

* CE correspondence

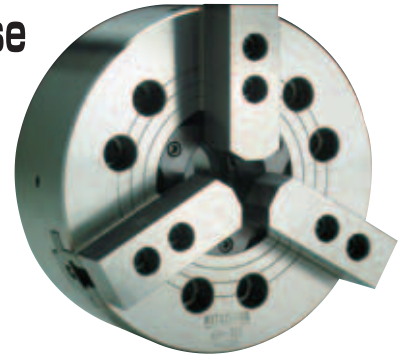

Standard Chuck

Dimensional Drawings

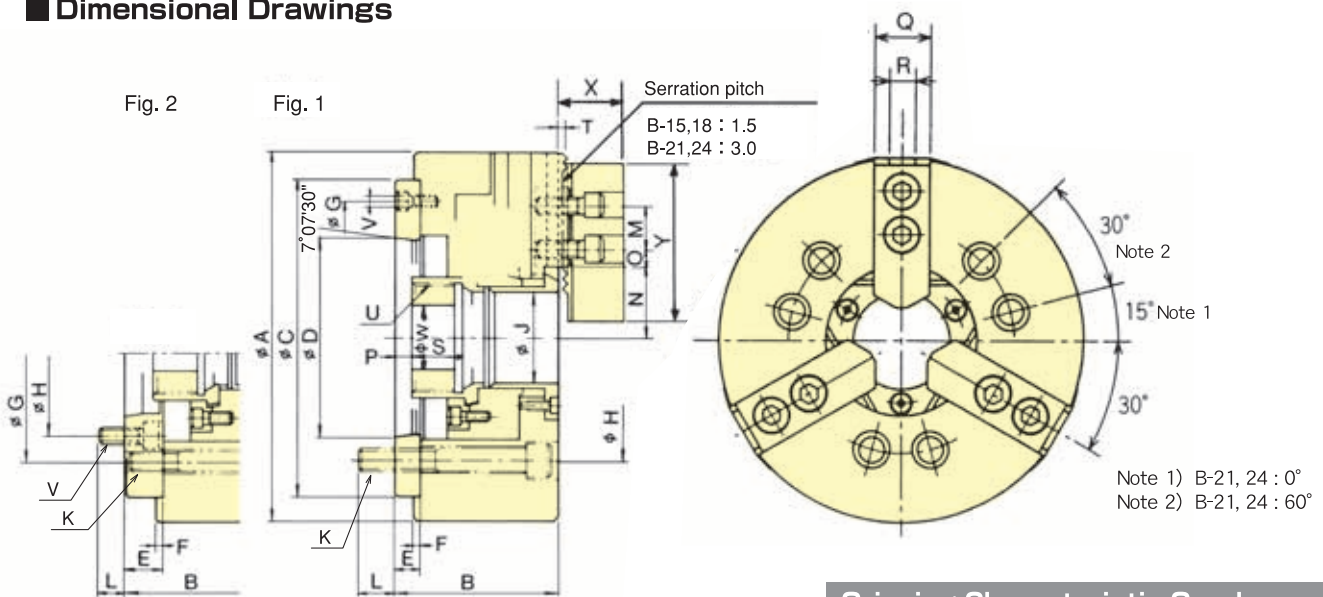

Gripping Characteristic Graphs

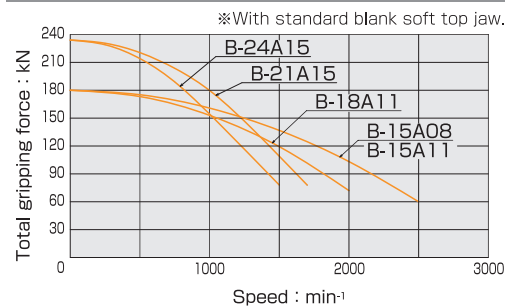

Dimensions

*B-15A08 is referred to in Fig.2. *Blank draw nut equipped.

Model	A	B	C	D	E	F	G	H	J	K	L	M	N max.	N min.	O max.	O min.	P max.	P min.	Q	R	S	T	U max.	V	W	X	Y
B-15A08	381	160	300	139.719	33	6	235	171.4	117.5	6-M20	24	43	82	76.7	43.75	18.25	44	21	62	22	39	5	M130x2	6-M16	60	70	165
B-15A11	381	149	300	196.869	22	6	260	235	117.5	6-M20	28	43	82	76.7	43.75	18.25	33	10	62	22	39	5	M130x2	3-M10	60	70	165
B-18A11	450	149	380	196.869	22	6	320	235	117.5	6-M20	28	43	82	76.7	78.25	18.25	33	10	62	22	39	5	M130x2	3-M10	60	70	165
B-21A15	530	161	380	285.775	27	6	330.2	330.2	140	6-M22	34	60	98.5	93.2	87.5	21.5	38	15	65	25	39	5	M155x3	3-M12	80	73	180
B-24A15	610	170	380	285.775	27	6	330.2	330.2	165	6-M22	35	60	108	102.7	117.5	21.5	47	24	65	25	40.5	5	M175x3	3-M12	80	73	180

Specifications

Model	Thru-Hole mm	Gripping range mm Max. Min.	Jaw Stroke (diameter) mm	Plunger Stroke mm	Max. Draw Bar Pull Force kN (kgf)	Max. Gripping Force kN (kgf)	Max. Speed min ⁻¹	Net Weight with Soft top jaws kg	Moment of inertia kg·m ²	Matching Cylinder	Max. pressure MPa(kgf/cm ²)	Matching Hard top jaw	Matching Soft top jaw	Spindle nose size
B-15A08	117.5	381 30	10.6	23	71 (7240)	180 (18355)	2500	134	2.47	F2511H	2.3 (23.5)	HB15A1	SB15C1	A2- 8
B-15A11	117.5	381 30	10.6	23	71 (7240)	180 (18355)	2500	127	2.385	F2511H	2.3 (23.5)	HB15A1	SB15C1	A2-11
B-18A11	117.5	450 30	10.6	23	71 (7240)	180 (18355)	2000	178	4.775	F2511H	2.3 (23.5)	HB15A1	SB15C1	A2-11
B-21A15	140	530 87	10.6	23	90 (9177)	234 (23861)	1700	246	9.25	F2511H	3.0 (30.6)	HB18B2	SB18A2	A2-15
B-24A15	165	610 109	10.6	23	90 (9177)	234 (23861)	1400	304	16.85	F2511H	3.0 (30.6)	HB18B2	SB18A2	A2-15



CHUCK

Large Thru-Hole Power Chuck BB200 series

Stable machining even for large diameter bar material
Universally recognised standard chuck



- Standard Soft Jaw can be used for B-200 series as well
- Large through-hole
6 inch ϕ 53 · 8 inch ϕ 66
10inch ϕ 81 · 12inch ϕ 106
- * CE correspondence

Dimensional Drawings

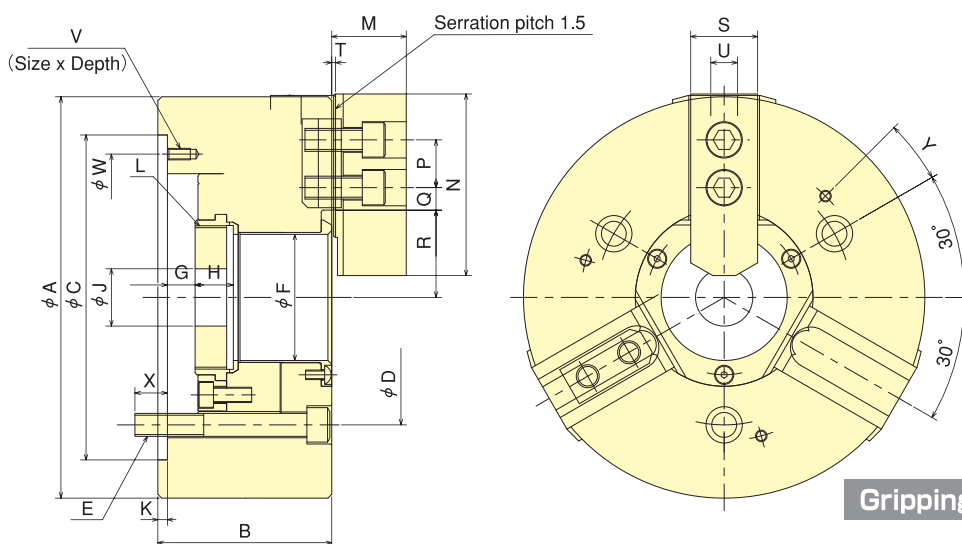

Gripping Characteristic Graphs

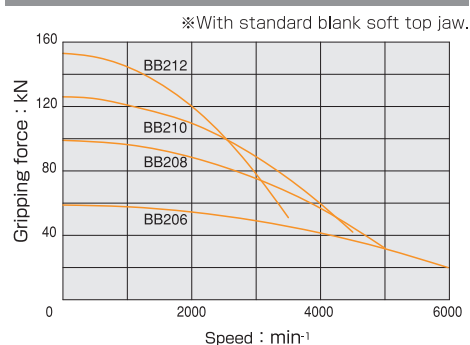

Dimensions

※Blank draw nut equipped.

Dimensions Model	A	B	C (H6)	D	E	F	G max.	G min.	H	J	K	L max.	M	N	P	Q max.	Q min.	R max.	R min.	S	T	U	V	W	X	Y
BB206	170	81	140	104.8	3-M10	53	11	-1	17.5	20	5	M60x2	33.2	72	20	21.25	10.75	36	33.25	31	2	12	M6x10	116	16	-30°
BB208	210	91	170	133.4	3-M12	66	14.5	-1.5	20	30	5	M75x2	39	95	25	23.75	11.75	45.7	42	35	2	14	M6x12	150	17	15°
BB210	254	100	220	171.4	3-M16	81	8.5	-10.5	25	45	5	M90x2	43.2	110	30	32.25	14.25	54	49.6	40	2	16	M8x15	190	22	-15°
BB212	315	108	300	235	3-M20	106	8	-15	28	50	6	M115x2	51.7	111	30	45.75	15.75	67.8	62.5	50	2.5	21	M10x16	260	29	-15°

Specifications

Specifications Model	Thru-Hole mm	Gripping range mm Max.	Gripping range mm Min.	Jaw Stroke (diameter) mm	Plunger Stroke mm	Max. Draw Bar Pull Force kN (kgf)	Max. Gripping Force kN (kgf)	Max. Speed min⁻¹	Net Weight with Soft top jaws kg	Moment of inertia kg·m²	Matching Cylinder	Max. pressure MPa (kgf/cm²)	Matching Soft top jaw
BB206	53	170	19	5.5	12	20 (2039)	58.5 (5965)	6000	11.7	0.050	SS1453K	1.88 (19.2)	SB06B1
BB208	66	210	23	7.4	16	32 (3263)	99 (10095)	5000	23	0.143	SS1666K	2.34 (23.9)	SB08B1
BB210	81	254	41	8.8	19	48.8 (4976)	126 (12848)	4500	31.8	0.312	SS1881K	3.09 (31.5)	SB10B1
BB212	106	315	47	10.6	23	59 (6016)	153 (15601)	3500	52	0.736	SS2110K	2.94 (30.0)	SB12N1



CHUCK

Large Thru-Hole High Speed Power Chuck BS300 series

Reduced Jaw Lift

The next generation chucking standard



- Compatible with B-200 series
- 30% drop in bending moment of Master-Jaw

30% Jaw lift reduction by side wedge design.
(Conventional Company Products : B-200 SERIES)

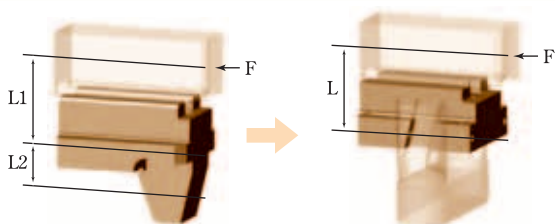

Existing Master-Jaw Side Wedge designed Master-Jaw

$$F (L1 + L2) \gg F \times L \approx 1.3 : 1$$

Dimensional Drawings

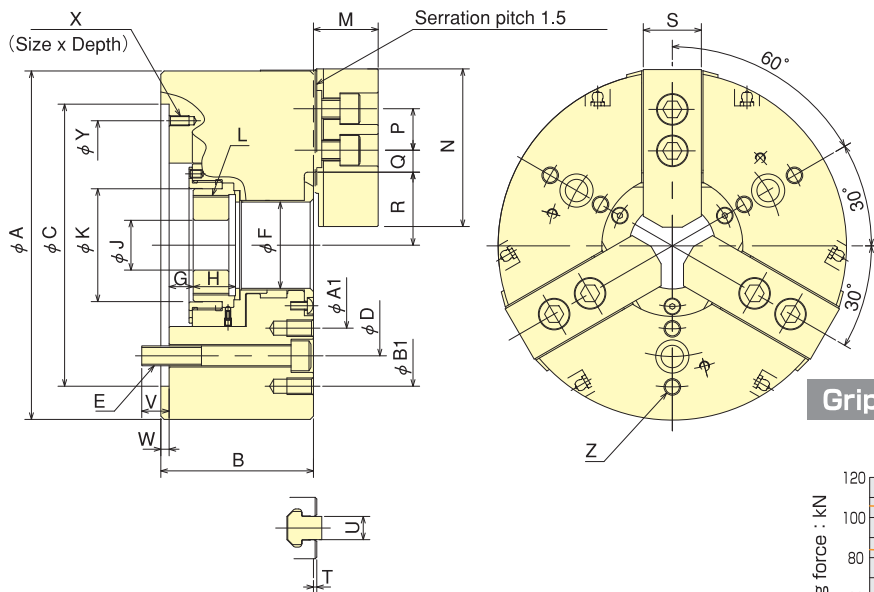

Gripping Characteristic Graphs

※With standard blank soft top jaw.

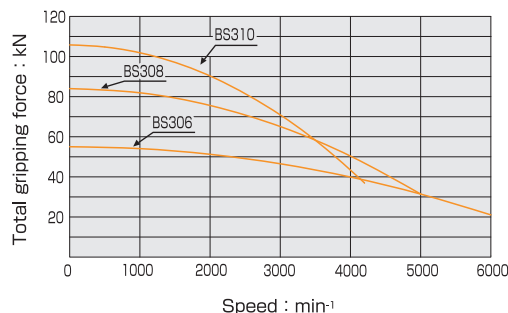

Dimensions ※Blank draw nut equipped.

Dimensions Model	A	B	C (H6)	D	E	F	G max.	G min.	H	J	K	L max.	M	N	P	Q max.	Q min.	R max.	R min.	S	T	U	V	W	X	Y	Z	A1	B1
BS306	169	85	140	104.8	3-M10	45	11	-1	20	20	61	M55×2	29	66	20	21.25	9.25	35	32.25	26	2	12	16.5	5	M6×10	116	3×2-M8	77.5	140
BS308	210	92	170	133.4	3-M12	52	14.5	0.5	25.5	30	68	M60×2	39	95	25	23.75	11.75	44	40.25	35	2	14	16.5	5	M6×12	150	3×2-M10	100	170
BS310	254	103	220	171.4	3-M16	75	8.5	-8.5	32.5	45	94	M85×2	43	110	30	30.75	11.25	55	50.45	40	2	16	23.2	5	M8×15	190	3×2-M10	128	216

Specifications

Specifications Model	Thru-Hole mm	Gripping range mm Max.	Gripping range mm Min.	Jaw Stroke (diameter) mm	Plunger Stroke mm	Max. Draw Bar Pull Force kN (kef)	Max. Gripping Force kN (kef)	Max. Speed min⁻¹	Net Weight with Soft top jaws kg	Moment of inertia kg·m²	Matching Cylinder	Max. pressure MPa (kef/cm²)	Matching Hard top jaw	Matching Soft top jaw
BS306	45	169	25	5.5	12	22 (2243)	55 (5610)	6000	11.5	0.060	S1246	2.8 (28.6)	HB06B1	SBO6L1A
BS308	52	210	18	7.5	14	34.8 (3549)	84 (8570)	5000	22.5	0.125	S1552	2.65 (27.0)	HB08B1	SBO8B1
BS310	75	254	33	9.1	17	43 (4385)	105.8 (10795)	4200	34.5	0.325	S1875	2.7 (27.5)	HB10AA1	SB10B1



CHUCK

Large Thru-Hole High Speed Power Chuck (Direct Mount) BS300A series

Equipped with Chuck Adaptor to suit Spindle Nose
Standard chuck for next generation



Standard Chuck

Dimensional Drawings

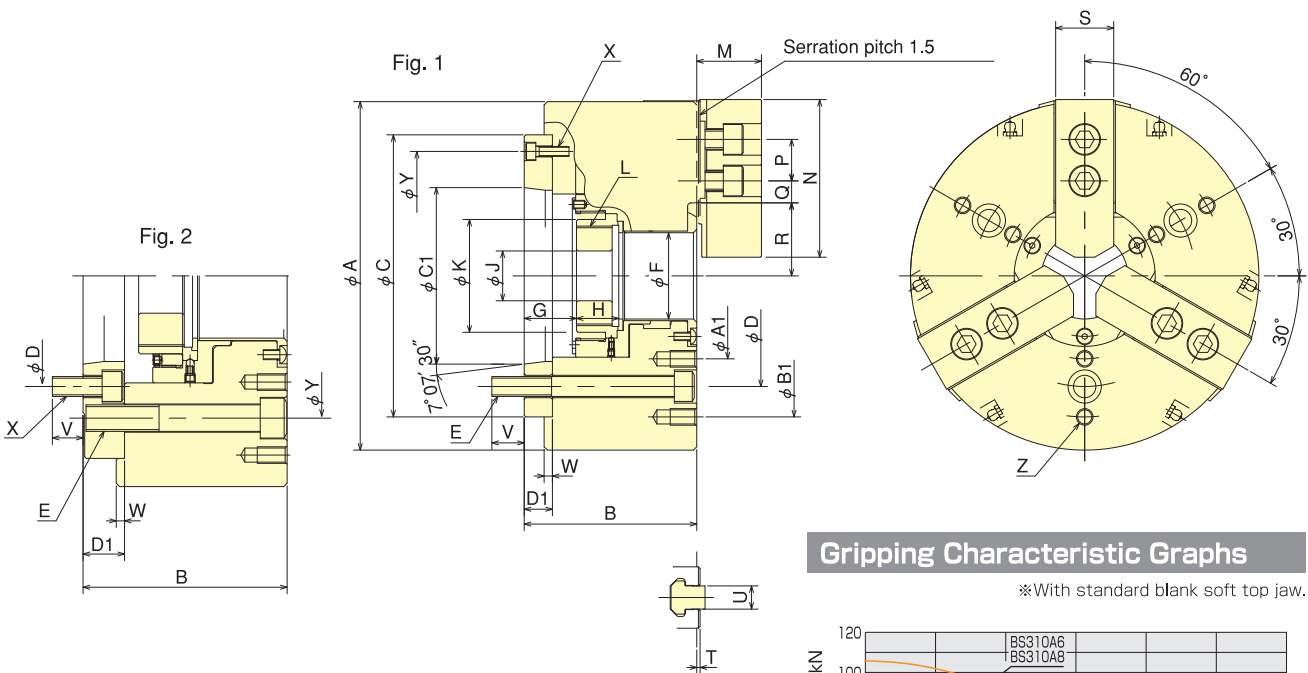

Gripping Characteristic Graphs

※With standard blank soft top jaw.

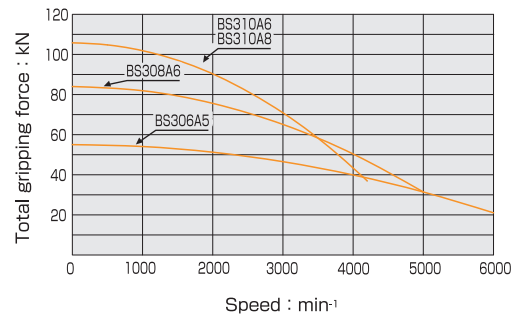

Dimensions

※BS310A6 is referred to in Fig.2. ※Blank draw nut equipped.

Dimensions Model	A	B	C	D	E	F	G max.	G min.	H	J	K	L max.	M	N	P	Q max.	Q min.	R max.	R min.	S	T	U	V	W	X	Y	Z	A1	B1	C1	D1
BS306A5	169	95	140	104.8	3-M10	45	26	14	20	20	61	M55×2	29	66	20	21.25	9.25	35	32.25	26	2	12	16.5	5	3-M 6	116	3×2-M8	77.5	140	82.563	15
BS308A6	210	104	170	133.4	3-M12	52	31.5	17.5	25.5	30	68	M60×2	39	95	25	23.75	11.75	44	40.25	35	2	14	19.5	5	3-M 6	150	3×2-M10	100	170	106.375	17
BS310A6	254	123	220	133.4	3-M16	75	33.5	16.5	32.5	45	94	M85×2	43	110	30	30.75	11.25	55	50.45	40	2	16	18.5	5	6-M12	171.4	3×2-M10	128	216	106.375	25
BS310A8	254	116	220	171.4	3-M16	75	26.5	9.5	32.5	45	94	M85×2	43	110	30	30.75	11.25	55	50.45	40	2	16	25.2	5	3-M 8	190	3×2-M10	128	216	139.719	18

Specifications

Specifications Model	Thru-Hole mm	Gripping range mm Max.	Gripping range mm Min.	Jaw Stroke (diameter) mm	Plunger Stroke mm	Max. Draw Bar Pull Force kN (kgf)	Max. Gripping Force kN (kgf)	Max. Speed min ⁻¹	Net Weight with Soft top jaws kg	Moment of inertia kg·m ²	Matching Cylinder	Max. pressure MPa(kgf/cm ²)	Matching Hard top jaw	Matching Soft top jaw	Spindle nose size
BS306A5	45	169	25	5.5	12	22 (2243)	55 (5610)	6000	12.7	0.063	S1246	2.8 (28.6)	HB06B1	SB06L1A	A2-5
BS308A6	52	210	18	7.5	14	34.8(3549)	84 (8570)	5000	24.4	0.135	S1552	2.65(27.0)	HB08A1	SB08B1	A2-6
BS310A6	75	254	33	9.1	17	43 (4385)	105.8(10795)	4200	40.3	0.368	S1875	2.7 (27.5)	HB10A1	SB10B1	A2-6
BS310A8	75	254	33	9.1	17	43 (4385)	105.8(10795)	4200	37.8	0.353	S1875	2.7 (27.5)	HB10A1	SB10B1	A2-8



CHUCK

Lever Style Power Chuck BL-200 series

Extra Long Jaw Stroke Flange work securely gripped

*CE correspondence



Dimensional Drawings

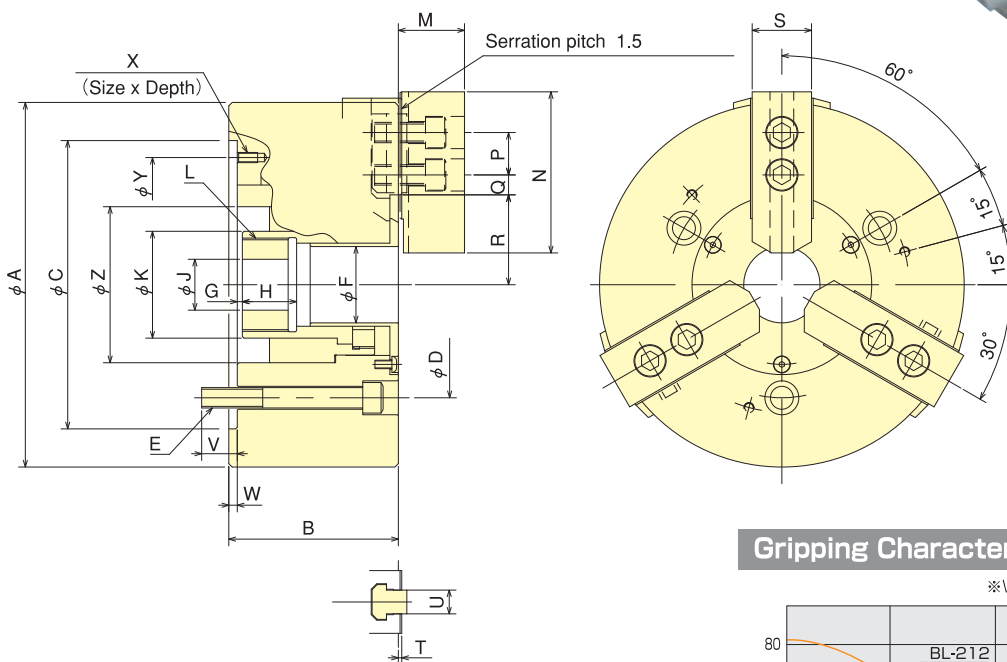

Gripping Characteristic Graphs

*With standard blank soft top jaw.

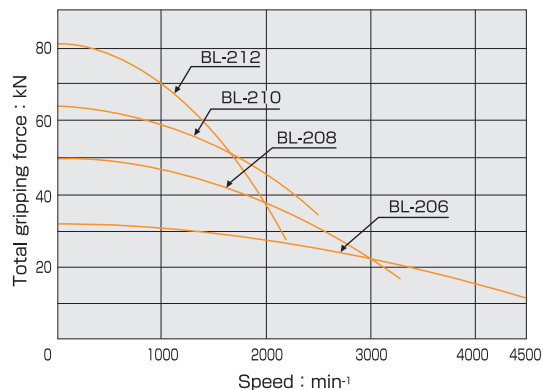

Dimensions *Blank draw nut equipped.

Dimensions Model	A	B	C (H6)	D	E	F	G max.	G min.	H	J	K	L max.	M	N	P	Q max.	Q min.	R max.	R min.	S	T	U	V	W	X (3-)	Y	Z
BL-206	165	87	140	104.8	3-M10	28	10	-5	24	20	45	M38x1.5	29	66	20	16.75	9.25	39.25	29.25	26	2	12	16	5	M6x12	116	70
BL-208	215	100	170	133.4	3-M12	45	3	-16	32	30	63	M55x2	39	95	25	20.75	11.75	53	40.5	35	2	14	21	5	M6x12	150	92
BL-210	254	117	220	171.4	3-M16	53	-6	-28	40	45	73	M65x2	43	110	30	26.25	11.25	62.5	47.5	40	2	16	27	5	M8x16	190	102
BL-212	304	138	220	171.4	3-M16	63	8.2	-16.8	38	50	83	M75x2	52	111	30	38.25	12.75	74.5	57	50	3	21	23	5	M8x16	190	120

Specifications

Specifications Model	Thru-Hole mm	Gripping range mm Max.	Gripping range mm Min.	Jaw Stroke (diameter) mm	Plunger Stroke mm	Max. Draw Bar Pull Force kN (kgf)	Max. Gripping Force kN (kgf)	Max. Speed min⁻¹	Net Weight with Soft top jaws kg	Moment of inertia kg·m²	Matching Cylinder	Max. pressure MPa (kgf/cm²)	Matching Hard top jaw	Matching Soft top jaw
BL-206	28	165	28	20	15	27.9 (2845)	31.2 (3182)	4500	14	0.043	S1246	3.40 (34.7)	HB06B1	SB06L1A
BL-208	45	215	32	25	19	41.1 (4191)	49.0 (4997)	3300	25	0.198	S1552	2.99 (30.5)	HB08A1	SB08B1
BL-210	53	254	42	30	22	53.8 (5486)	63 (6424)	3000	45	0.306	S1875	3.20 (32.6)	HB10A1	SB10B1
BL-212	63	304	43	35	25	69.3 (7067)	80.4 (8199)	2200	78	0.918	S2091	3.22 (32.8)	HB12N1	SB12N1



CHUCK

Lever Style Power Chuck (Direct Mount) BL200A series

Chuck Adaptor is equipped to suit Spindle Nose Flange work securely gripped

* CE correspondence



Standard Chuck

Dimensional Drawings

Fig.2

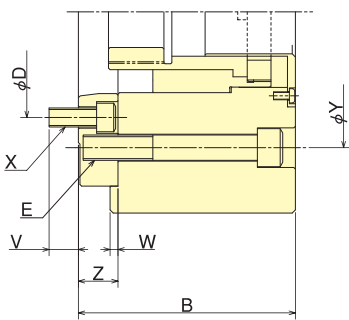
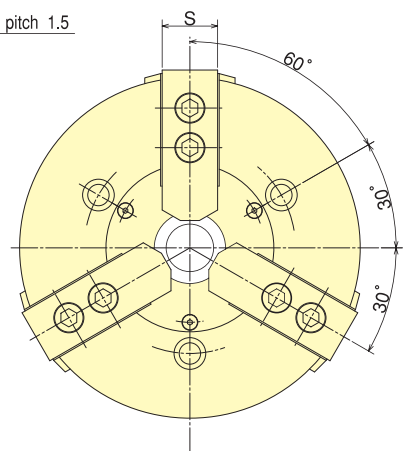
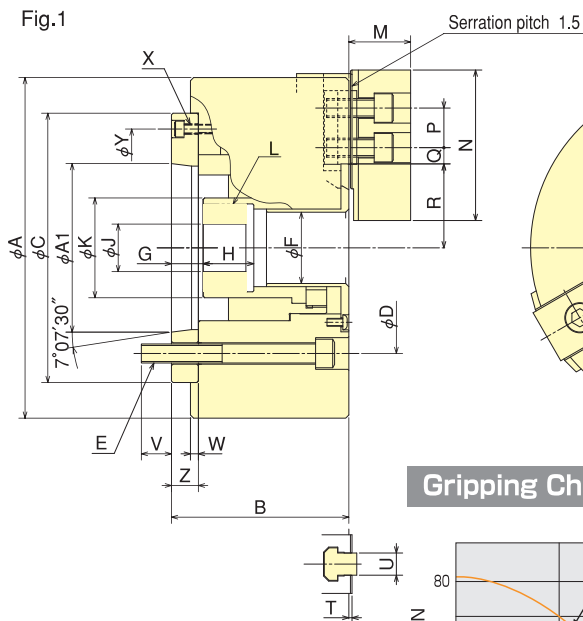
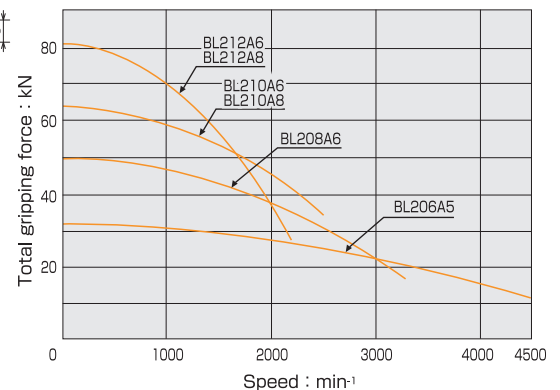

Fig.1



Gripping Characteristic Graphs

*With standard blank soft top jaw.



Dimensions

*BL210A6 and BL212A6 are based on Fig. 2. *Blank draw nut equipped.

Dimensions Model	A	B	C	D	E	F	G max.	G min.	H	J	K	L max.	M	N	P	Q max.	Q min.	R max.	R min.	S	T	U	V	W	X	Y	Z	A1
BL206A5	165	97	140	104.8	3-M10	28	25	10	24	20	45	M38x1.5	29	66	20	16.75	9.25	39.25	29.25	26	2	12	16	5	3-M6	116	15	82.563
BL208A6	215	112	170	133.4	3-M12	45	20	1	32	30	63	M55x2	39	95	25	20.75	11.75	53	40.5	35	2	14	19	5	3-M6	150	17	106.375
BL210A6	254	137	220	133.4	3-M16	53	19	-3	40	45	73	M65x2	43	110	30	26.25	11.25	62.5	47.5	40	2	16	18.5	5	6-M12	171.4	25	106.375
BL210A8	254	130	220	171.4	3-M16	53	12	-10	40	45	73	M65x2	43	110	30	26.25	11.25	62.5	47.5	40	2	16	24	5	3-M8	190	18	139.719
BL212A6	304	158	220	133.4	3-M16	63	33.2	8.2	38	50	83	M75x2	52	111	30	38.25	12.75	74.5	57	50	3	21	18.5	5	6-M12	171.4	25	106.375
BL212A8	304	151	220	171.4	3-M16	63	26.2	1.2	38	50	83	M75x2	52	111	30	38.25	12.75	74.5	57	50	3	21	25	5	3-M8	190	18	139.719

Specifications

Specifications Model	Thru-Hole mm	Gripping range mm Max. Min.	Jaw Stroke (diameter) mm	Plunger Stroke mm	Max. Draw Bar Pull Force kN (kgf)	Max. Gripping Force kN (kgf)	Max. Speed min⁻¹	Net Weight with Soft top jaws kg	Moment of inertia kg·m²	Matching Cylinder	Max. pressure MPa(kgf/cm²)	Matching Hard top jaw	Matching Soft top jaw	Spindle nose size
BL206A5	28	165 28	20	15	27.9(2845)	31.2(3182)	4500	15.2	0.048	S1246	3.40(34.7)	HB06B1	SB06L1A	A2-5
BL208A6	45	215 32	25	19	41.1(4191)	49.0(4997)	3300	26	0.208	S1552	2.99(30.5)	HB08A1	SB08B1	A2-6
BL210A6	53	254 42	30	22	53.8(5486)	63(6424)	3000	50.5	0.351	S1875	3.20(32.6)	HB10A1	SB10B1	A2-6
BL210A8	53	254 42	30	22	53.8(5486)	63(6424)	3000	48	0.325	S1875	3.20(32.6)	HB10A1	SB10B1	A2-8
BL212A6	63	304 43	35	25	69.3(7067)	80.4(8199)	2200	78	0.918	S2091	3.22(32.8)	HB12N1	SB12N1	A2-6
BL212A8	63	304 43	35	25	69.3(7067)	80.4(8199)	2200	81.2	0.943	S2091	3.22(32.8)	HB12N1	SB12N1	A2-8



CHUCK

Counter Balanced Power Chuck HOH series

Counter Balance Design Secure gripping at high speeds

*CE correspondence



Dimensional Drawings

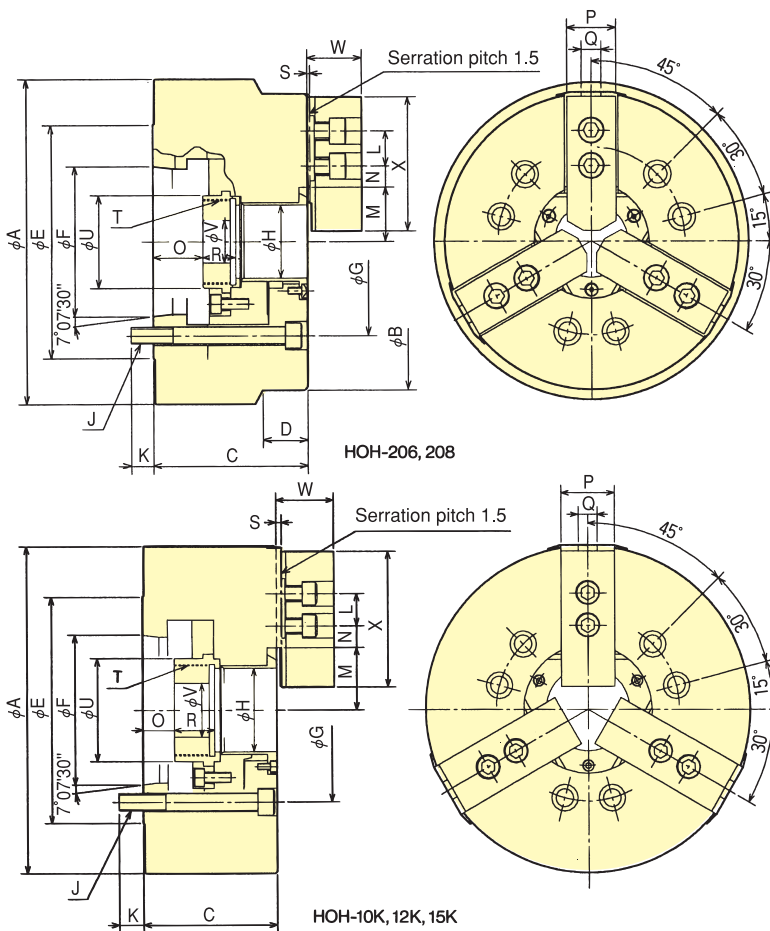

Gripping Characteristic Graphs

※With standard blank soft top jaw.

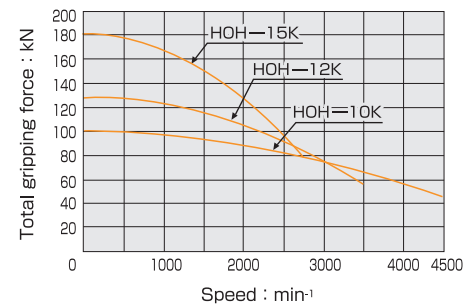
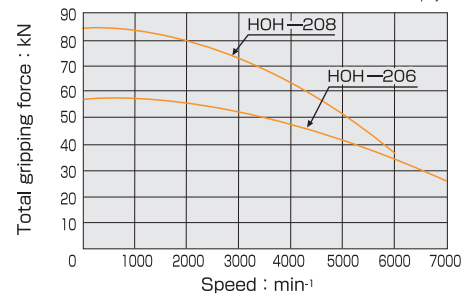

Dimensions ※Blank draw nut equipped.

Dimensions	A	B	C	D	E	F	G	H	J	K	L	M	M	N	N	O	O	P	Q	R	S	T	U	V	W	X
Model												max.	min.	max.	min.	max.	min.					max.				
HOH-206	175	169	95	322	135	82.563	104.8	45	6-M10	17	20	32	29.25	22.75	9.25	30	18	26	12	19	2	M55×2	60	20	29	66
HOH-208	230	210	110	32	165	106.375	133.4	52	6-M12	16	25	38.7	35	29.75	14.75	35.5	19.5	35	14	23.5	2	M60×2	66	30	39	95
HOH-10K	254	-	114	-	210	139.719	171.4	65	6-M16	24	30	50	45.6	32.25	12.75	14	-5	40	16	35	5	M75×2	84.5	45	46	110
HOH-12K	304	-	125	-	210	139.719	171.4	78	6-M16	23	30	58	52.7	48.75	14.25	29	6	50	18	38	5	M88×2	96	50	54	129
HOH-15K	381	-	154	-	280	196.869	235	117.5	6-M20	30	43	82	76.7	43.75	18.25	38	15	62	22	39	5	M130×2	139	60	70	165

Specifications ※Max speed is shown using actual test data.

Specifications	Thru-Hole	Gripping range	Jaw Stroke	Plunger	Max. Draw Bar	Max. Gripping	Max. Speed	Net Weight	Moment of inertia	Matching	Max. pressure	Matching	Matching	Spindle
Model	mm	Max. Min.	(diameter) mm	Stroke mm	Pull Force kN (kgf)	Force kN (kgf)	min⁻¹	with Soft top jaws kg	kg·m²	Cylinder	MPa(kgf/cm²)	Hard top jaw	Soft top jaw	nose size
HOH-206	45	169 16	5.5	12	22(2243)	57(5812)	7000	15.7	0.068	S1246	2.8(28.5)	HB06B1	SB06L1A	A2- 5
HOH-208	52	210 13	7.4	16	34(3467)	84(8566)	6000	29	0.193	S1552	2.6(26.5)	HB08A1	SB08B1	A2- 6
HOH-10K	65	254 25	8.8	19	38(3875)	99(10095)	4500	40	0.350	S1875	2.3(23.5)	HB10A1	SB10B1	A2- 8
HOH-12K	78	304 23	10.6	23	49(4997)	129(13154)	3500	67	0.875	S2091	2.3(23.5)	HB12B1	SB12A1	A2- 8
HOH-15K	117.5	381 30	10.6	23	71(7240)	180(18355)	2800	124	2.550	F2511H	2.3(23.5)	HB15A1	SB15C1	A2-11



CHUCK

Quick Jaw-Change Chuck QB300 series

Easy set-up and Quick Change of Top Jaw

*CE correspondence
 CE Correspondence (QB300N)
 The specification is the same as that of QB300 chuck except jaw release handle.



Standard Chuck

Dimensional Drawings

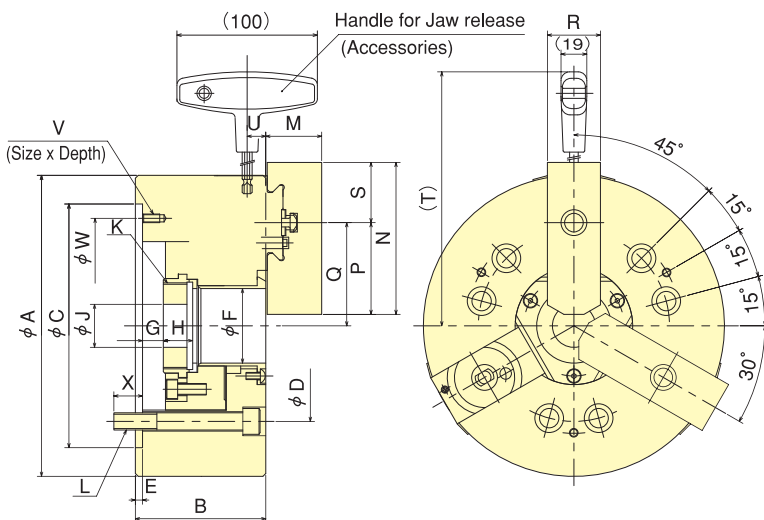

Gripping Characteristic Graphs

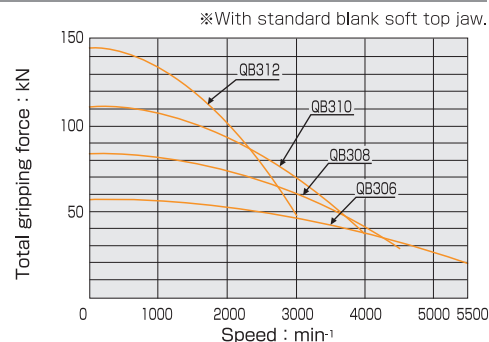

Note) Please contact our engineering regarding casting and forgin material machining.

Dimensions *Blank draw nut equipped.

Dimensions Model	A	B	C (H6)	D	E	F	G max.	G min.	H	J	K max.	L	M	N	P	Q max.	Q min.	R	S	T	U	V	W	X
QB306	169	81	140	104.8	5	45	11	-1	19	20	M55x2	6-M10	31	90	54	58.5	55.75	32	36	192.5	13	M6x10	116	16
QB308	210	91	170	133.4	5	52	14.5	-1.5	20.5	30	M60x2	6-M12	39	106	64	72	68.3	37	42	220.7	13	M6x12	150	20
QB310	254	100	220	171.4	5	75	8.5	-10.5	25	45	M85x2	6-M16	43	125	76	88	83.6	42	49	242	15.5	M8x15	190	22
QB312	304	110	220	171.4	6	91	8	-15	28	50	M100x2	6-M16	51	139	90	106.3	101	42	49	267	15.5	M8x15	190	23

Specifications *Max speed is shown using actual test data.

Specifications Model	Thru-Hole mm	Outer gripping range mm	Jaw Stroke (diameter) mm	Plunger Stroke mm	Max. Draw Bar Pull Force kN (kgf)	Max. Gripping Force kN (kgf)	Max. Speed min ⁻¹	Net Weight with Soft top jaws kg	Moment of inertia kg·m ²	Matching Cylinder	Max. pressure MPa (kgf/cm ²)	Matching Soft top jaw
QB306	45	φ10~φ140	5.5	12	22 (2243)	57 (5812)	5500	12.6	0.058	S1246	2.8 (28.6)	SB06BB
QB308	52	φ18~φ180	7.4	16	34 (3467)	84 (8565)	4500	23.2	0.173	S1552	2.6 (26.5)	SB08BB
QB310	75	φ22~φ210	8.8	19	43 (4385)	111 (11319)	4000	35	0.318	S1875	2.7 (27.5)	SB10BB
QB312	91	φ30~φ250	10.6	23	55 (5608)	144 (14684)	3000	67	0.745	S2091	2.7 (27.5)	SB12BB

Soft Top Jaw Dimensional Drawings

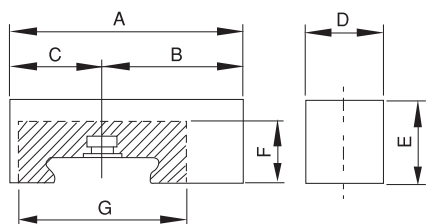

Note) No modification is allowed in shaded area.

Dimensions for Soft Top Jaw

Soft Jaw Model Dimensions	6"		8"		10"		12"	
	SB06BB	SB06BB-040	SB08BB	SB08BB-056	SB10BB	SB10BB-060	SB12BB	SB12BB-070
A	90	90	106	106	125	125	139	139
B	54	54	64	64	76	76	90	90
C	36	36	42	42	49	49	49	49
D	32	32	37	37	42	42	42	42
E	30	40	38	56	42	60	50	70
F	24	24	28	28	31	31	34	34
G	68	68	76	76	88	88	92	92
Min. gripper range	10	10	18	18	22	22	30	30



CHUCK

Quick Jaw Replacement Chuck

QJR series

Suitable for small and large batch production
Quick & smooth Jaw Replacement

Quick Jaw Replacement

Jaw can be replaced quickly and easily by handle supplied.

Suitable for small and large batch production

Reduced set up time by Quick and Easy Jaw Replacement.

Interchangeable mounting dimensions

Kitagawa's B-200 and BB200 series can be easily replaced with QJR large thru-hole power chucks.

Base jaws and Soft jaws are available as option.



Standard Chuck

Dimensional Drawings

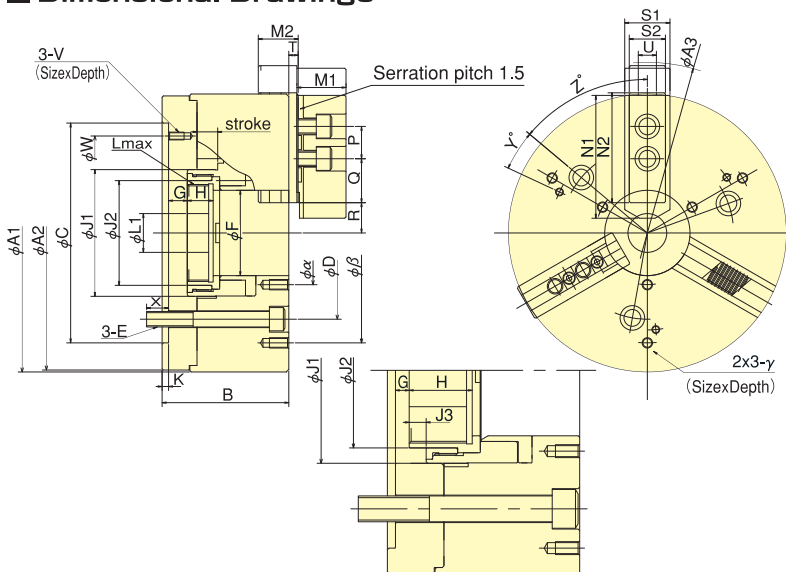

Gripping Characteristic Graphs

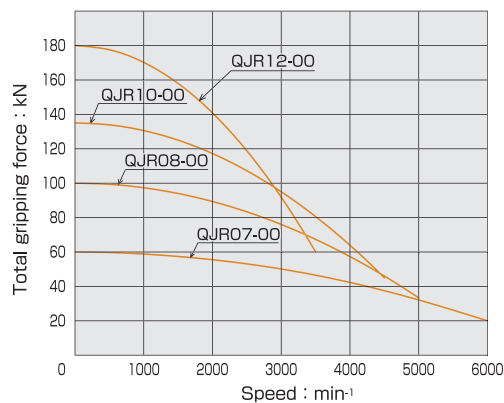

*Graphs show the relationship between the rotation speed and the gripping force at the position of aligning base jaws with chuck OD when using standard soft jaws.
 *Centrifugal force is different vastly depending on the size, shape or orientation of top jaws, or the position to insert base jaws.

Dimensions

Model	A1	A2	A3	B	C (H6)	D	E	F	G max.	G min.	H	J1	J2	J3	K	L max.	L1	M1	M2
QJR07-00	178	178	212	92	140	104.8	M10	53	11	-4	24	81	66	9.5	5	M60x2	20	32	25.5
QJR08-00	215	212	264	98	170	133.4	M12	66	14.5	-1.5	20	98	81	-	5	M75x2	30	38	30.8
QJR10-00	254	251	312	119	220	171.4	M16	81	8.5	-10.5	39	115	96	10.5	5	M90x2	45	42	39
QJR12-00	315	312	360	133	220(300)	171.4(235)	M16(M20)	106	8	-15	42	140	121	15	6	M115x2	50	50	45.2

Model	N1	N2	P	Q	R max.	R min.	S1	S2	T	U	V	W	X	Y	Z	α	β	γ
QJR07-00	72	73	20	28.5	14 -32	10.3-28.3	31	25.5	5.45	12	M6x12	116	17	-30	50	75	155	M8x13
QJR08-00	95	85	25	34	20.4-44.4	16.7-40.7	35	28	7.25	14	M6x12	150	17	15	50	80	170	M8x15
QJR10-00	110	100.5	30	40.5	21.2-52.7	16.8-48.3	40	35	11.3	16	M8x15	190	23	-15	50	100	220	M8x15
QJR12-00	111	108	30	57	33.9-69.9	28.6-64.6	50	50	12	21	M8x15(M10x16)	190(260)	22(27)	-15	45(50)	130	280	M10x17

Specifications

The numbers in () are the dimension of QJR12-00 for interchangeable BB212. Please contact us for more details.

Model	Thru-Hole mm	Gripping range mm		Jaw Stroke (diameter) mm	Plunger Stroke mm	Max. Draw Bar Pull Force kN	Max. Gripping Force kN	Max. Speed min ⁻¹	Net Weight with Soft top jaws kg	Moment of inertia kg·m ²	Option	
		Max.	Min.								Matching Base jaw	Matching Soft top jaw
QJR07-00	53	178	19	7.4	15	25	60	6000	14	0.06	QJR07-BJ00	SBO6B1
QJR08-00	66	210	23	7.4	16	45	100	5000	25	0.18	QJR08-BJ00	SBO8B1
QJR10-00	81	254	41	8.8	19	60	135	4500	45	0.41	QJR10-BJ00	SB10B1
QJR12-00	106	315	47	10.6	23	81	180	3500	75	1.15	QJR12-BJ00	SB12N1

The models above are not included Base jaws or Soft jaws. Please refer above list when ordering Base jaws and soft jaws.



CHUCK

2 Jaw Large Thru-Hole High Speed Power Chuck BT200 series

For gripping Irregular shaped components

* CE correspondence



Standard Chuck

Gripping Examples

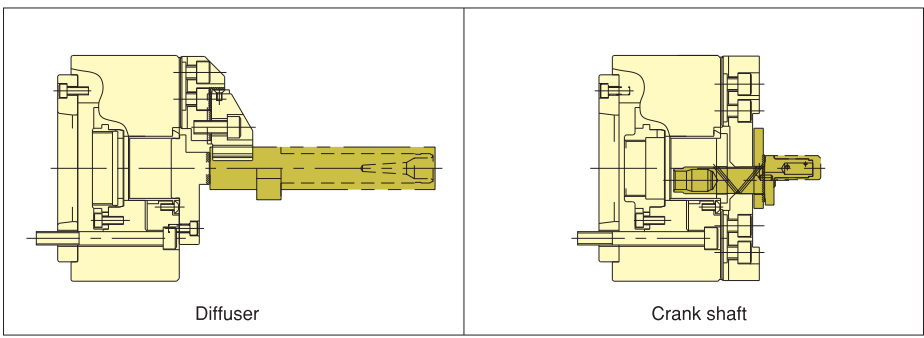

Dimensional Drawings

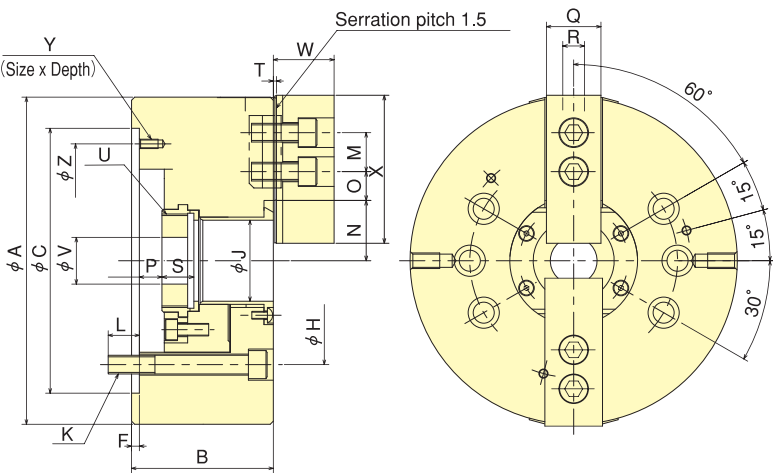

Gripping Characteristic Graphs

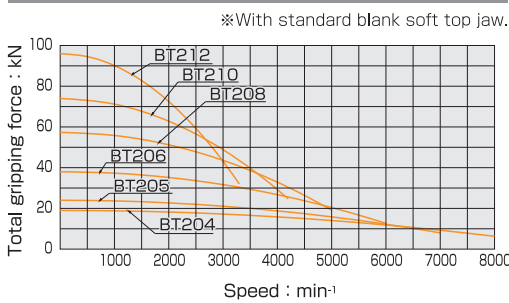

Dimensions

※Mounting bolt P. C. D. for BT204 & BT205 : each 60° from jaw centre : 4 pcs. ※Blank draw nut equipped.

Dimensions Model	A	B	C (H6)	F	H	J	K	L	M	N max.	N min.	O max.	O min.	P max.	P min.	Q	R	S	T	U max.	V	W	X	Y	Z
BT204	110	59	85	4	70.6	26	4-M10	15.5	14	23	20.3	11.25	6.75	3.5	- 6.5	23	10	17.5	2	M32x1.5	12	24	49.5	-	-
BT205	135	60	110	4	82.55	33	4-M10	15	14	26.5	23.8	19.75	7.75	1	- 9	23	10	20	2	M40x1.5	12	26	54	-	-
BT206	169	81	140	5	104.8	45	6-M10	16	20	32	29.25	22.75	9.25	11	- 1	26	12	19	2	M55x2	20	29	66	M6x10	116
BT208	210	91	170	5	133.4	52	6-M12	20	25	38.7	35	30	15	14.5	- 1.5	35	14	20.5	2	M60x2	30	39	95	M6x12	150
BT210	254	100	220	5	171.4	75	6-M16	22	30	51	46.6	34	14.5	8.5	- 10.5	40	16	25	2	M85x2	45	43	110	M8x15	190
BT212	304	110	220	6	171.4	91	6-M16	23	30	61.3	56	45.75	15.75	8	- 15	50	21	28	2	M100x2	50	51	111	M8x15	190

Specifications

※Max speed is shown using actual test data.

Specifications Model	Thru-Hole mm	Gripping range mm Max. Min.	Jaw Stroke (diameter) mm	Plunger Stroke mm	Max. Draw Bar Pull Force kN (kgf)	Max. Gripping Force kN (kgf)	Max. Speed min ⁻¹	Net Weight with Soft top jaws kg	Moment of inertia kg·m ²	Matching Cylinder	Max. pressure MPa (kgf/cm ²)	Matching Soft top jaw
BT204	26	110 7	5.4	10	9.3 (948)	19 (1937)	8000	3.8	0.006	F0933H	1.94 (19.8)	SB04N1T
BT205	33	135 12	5.4	10	11.7 (1193)	24 (2447)	7000	6.5	0.017	F0933H	2.38 (24.3)	SB05N1T
BT206	45	169 14	5.5	12	14.5 (1479)	38 (3875)	6000	11.5	0.056	S1246	1.85 (18.9)	SB06L1T
BT208	52	210 14	7.4	16	23.2 (2366)	57.3 (5843)	5000	21.3	0.165	S1552	1.80 (18.4)	SB08A1T
BT210	75	254 31	8.8	19	28.5 (2906)	74 (7546)	4200	33.5	0.308	S1875	1.80 (18.4)	SB10A1T
BT212	91	304 34	10.6	23	36.7 (3742)	96 (9789)	3300	52	0.700	S2091	1.81 (18.5)	SB12N1T

※Altering Back Plate enables to change over 3-Jaw Chuck into 2-Jaw Chuck.



CHUCK

2-Jaw Large Thru-Hole Power Chuck BBT200 series

For gripping the Irregular shaped components
2-Jaw type of BB200 series



- Large thru-hole
6 inch ϕ 53 · 8 inch ϕ 66
10 inch ϕ 81 · 12 inch ϕ 106
- *CE correspondence

Standard Chuck

Dimensional Drawings

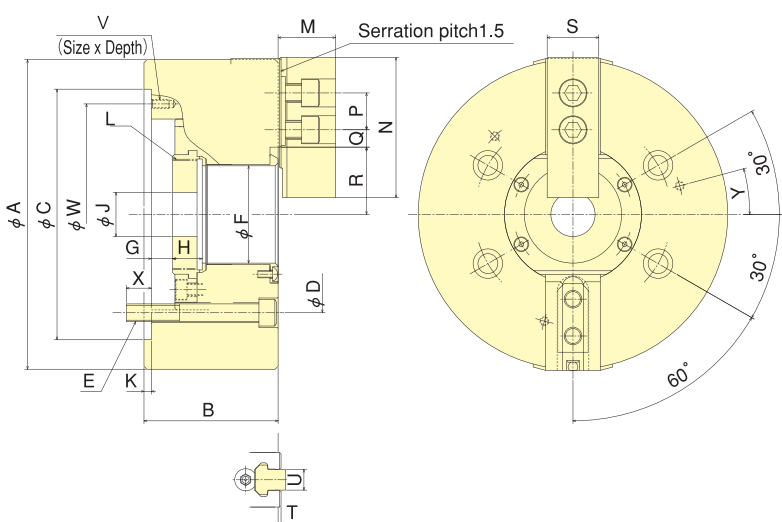

Gripping Characteristic Graphs

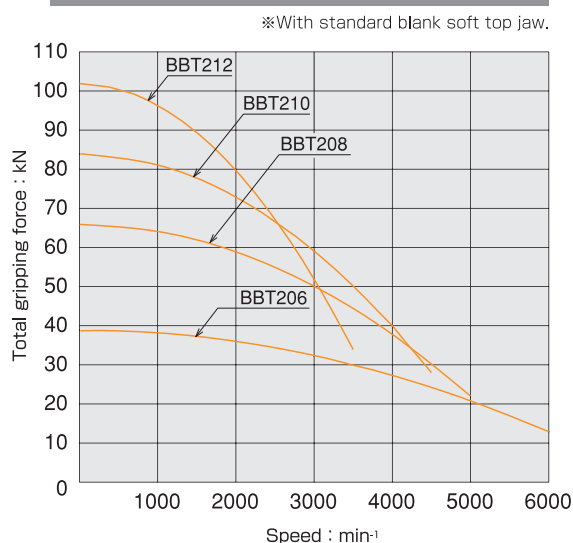

Dimensions

※Blank draw nut equipped.

Model	A	B	C (H6)	D	E	F	G max.	G min.	H	J	K	L max.	M	N	P	Q max.	Q min.	R max.	R min.	S	T	U	V	W	X	Y
BBT206	170	81	140	104.8	4-M10	53	11	-1	17.5	20	5	M60x2	33.2	72	20	21.25	10.75	36	33.25	31	2	12	M6x10	116	16	0°
BBT208	210	91	170	133.4	4-M12	66	14.5	-1.5	20	30	5	M75x2	39	95	25	24	12	45.7	42	35	2	14	M6x12	150	17	15°
BBT210	254	100	220	171.4	4-M16	81	8.5	-10.5	25	45	5	M90x2	43.2	110	30	32.50	14.5	54	49.6	40	2	16	M8x15	190	22	15°
BBT212	315	108	300	235	4-M20	106	8	-15	28	50	6	M115x2	51.7	111	30	45.75	15.75	67.8	62.5	50	2.5	21	M10x16	260	29	15°

Specifications

Model	Thru-Hole mm	Gripping range mm Max. Min.	Jaw Stroke (diameter) mm	Plunger Stroke mm	Max. Draw Bar Pull Force kN (kgf)	Max. Gripping Force kN (kgf)	Max. Speed min ⁻¹	Net Weight with Soft top jaws kg	Moment of inertia kg·m ²	Matching Cylinder	Max. pressure MPa (kgf/cm ²)	Matching Soft top jaw
BBT206	53	170 19	5.5	12	13.3 (1356)	38.9 (3967)	6000	11.4	0.048	SS1453K	1.33 (13.6)	SB06A1T
BBT208	66	210 23	7.4	16	21.3 (2172)	65.9 (6720)	5000	21.5	0.137	SS1666K	1.64 (16.7)	SB08A1T
BBT210	81	254 41	8.8	19	32.5 (3314)	83.9 (8555)	4500	30.8	0.292	SS1881K	2.14 (21.8)	SB10A1T
BBT212	106	315 47	10.6	23	39.3 (4007)	101.9 (10391)	3500	50.2	0.706	SS2110K	2.05 (20.9)	SB12N1T

※Altering Back Plate enables to change over 3-Jaw Chuck into 2-Jaw Chuck.



CHUCK

2-Jaw Lever Style Power Chuck BLT200 series

Extra Long Jaw Stroke for gripping Irregular shaped components
Flange work securely gripped

* CE correspondence



Standard Chuck

Gripping Examples

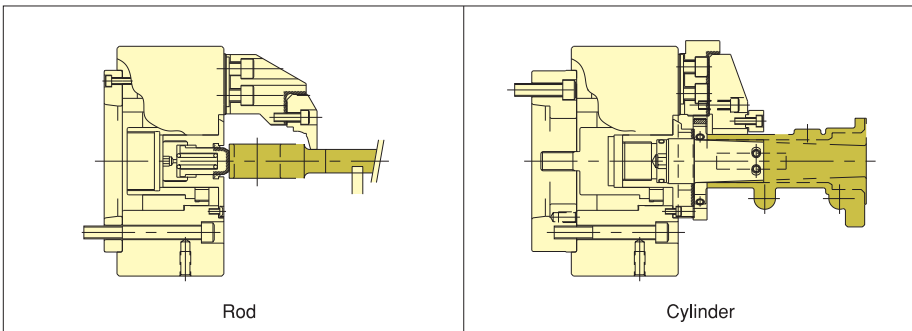

Rod

Cylinder

Dimensional Drawings

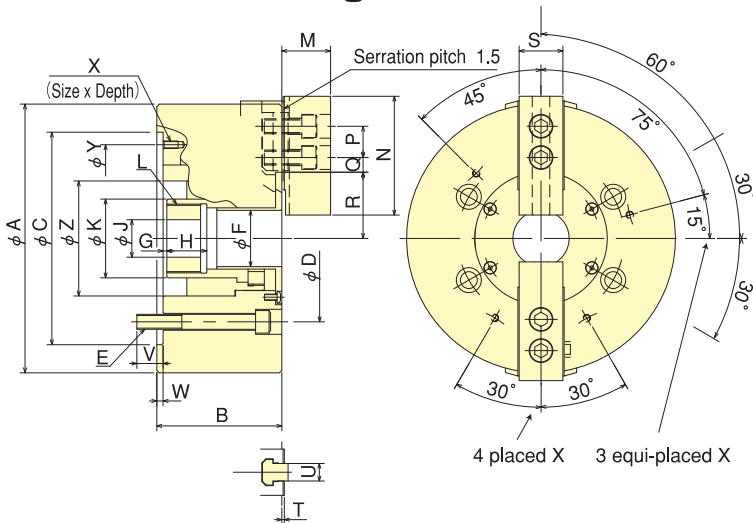

Gripping Characteristic Graphs

※With standard blank soft top jaw.

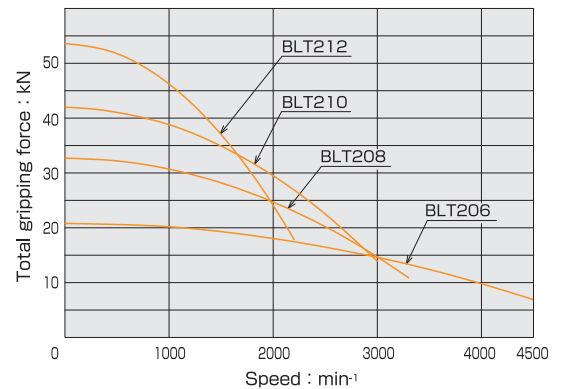

Dimensions

※Blank draw nut equipped.

Dimensions Model	A	B	C (H6)	D	E	F	G max.	G min.	H	J	K	L max.	M	N	P	Q max.	Q min.	R max.	R min.	S	T	U	V	W	X	Y	Z
BLT206	165	87	140	104.8	4-M10	28	10	-5	24	20	45	M38×1.5	29	66	20	16.75	9.25	39.25	29.25	26	2	12	16	5	4-M6×12	116	70
BLT208	215	100	170	133.4	4-M12	45	3	-16	32	30	63	M55×2	39	95	25	21	12	53	40.5	35	2	14	21	5	3-M6×12	150	92
BLT210	254	117	220	171.4	4-M16	53	-6	-28	40	45	73	M65×2	43	110	30	26.5	11.5	62.5	47.5	40	2	16	27	5	3-M8×16	190	102
BLT212	304	138	220	171.4	4-M16	63	8.2	-16.8	38	50	83	M75×2	52	111	30	38.25	12.75	74.5	57	50	3	21	23	5	3-M8×16	190	120

Specifications

Specifications Model	Thru-Hole mm	Gripping range mm Max. Min.	Jaw Stroke (diameter) mm	Plunger Stroke mm	Max. Draw Bar Pull Force kN (kgf)	Max. Gripping Force kN (kgf)	Max. Speed min⁻¹	Net Weight with Soft top jaws kg	Moment of inertia kg·m²	Matching Cylinder	Max. pressure MPa (kgf/cm²)	Matching Soft top jaw
BLT206	28	165 28	20	15	18.6 (1897)	20.8 (2121)	4500	13.5	0.042	S1246	2.36 (24.1)	SB06L1T
BLT208	45	215 32	25	19	27.4 (2794)	32.7 (3334)	3300	24	0.193	S1552	2.08 (21.2)	SB08A1T
BLT210	53	254 42	30	22	35.9 (3661)	42 (4283)	3000	43.5	0.290	S1875	2.20 (22.4)	SB10A1T
BLT212	63	304 43	35	25	46.2 (4711)	53.6 (5465)	2200	75.5	0.903	S2091	2.22 (22.6)	SB12N1T

※Altering Back Plate enables to change over 3-Jaw Chuck into 2-Jaw Chuck.



CHUCK

3-Jaw Air-Operated Self Contained Chuck UVE-K series

Built-in Pneumatic Cylinder



Dimensional Drawings

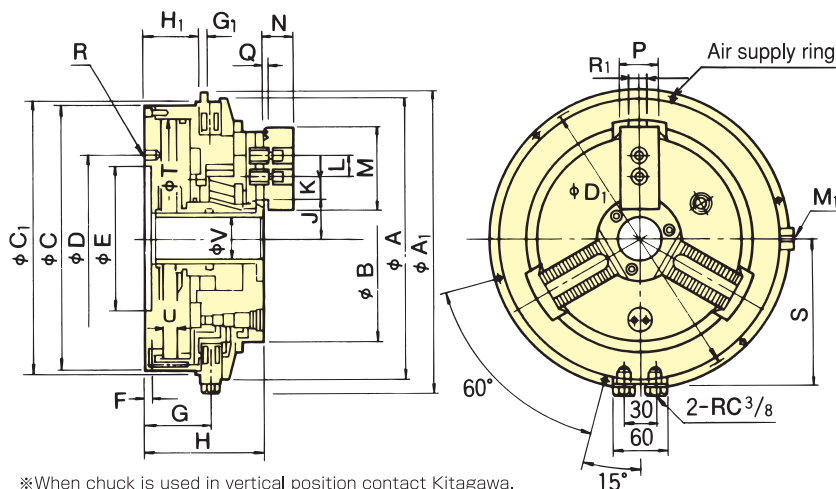

※When chuck is used in vertical position contact Kitagawa.

Gripping Characteristic Graphs

※Each curve shows air pressure 0.6MPa (6.1kgf/cm²). This is a case that standard soft jaws are used.

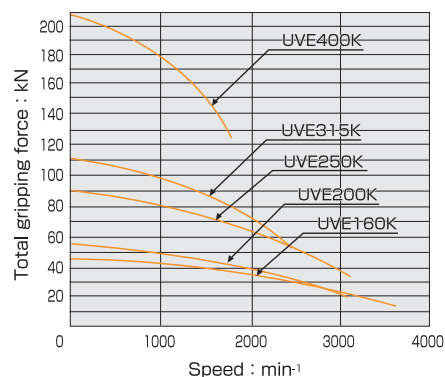

Dimensions

Mode	A	B	C	D	E (H7)	F	G	H	J max.	J min.	K max.	K min.	L	M	N	P	Q	R	S	T	U	V	A ₁	C ₁ (h6)	D ₁	G ₁	H ₁ ±0.1	M ₁	R ₁
UVE160K	250	170	230	180	160	6.5	83	137	33.5	29.3	19.25	10.25	25	76.5	38.5	40	2.25	6-M10	138	205	24	38	273	240	260	6	71	M10	14
UVE200K	280	200	260	210	185	8	82.5	141	43	38.8	20.25	11.25	30	110	43	40	2.25	6-M10	150	230	24	50	302	275	288	6	69	M10	16
UVE250K	330	250	310	260	235	8	87.5	151	47.5	42.6	39.75	12.75	30	110	43	40	2.25	6-M10	175	280	28	60	350	320	336	6	74	M12	16
UVE315K	385	315	365	315	290	8	90.5	155	64	59.1	46.25	14.75	38	129	51	50	2.25	6-M10	206	335	28	92	410	380	395	8	77	M12	18
UVE400K	495	400	475	340	300	8	118	200	86	79	37.5	16.5	60	156	71	62	3.3	6-M16	257	440	40	120	518	485	505	8	104	M16	22

Specifications

Mode	Thru-Hole mm	Gripping range mm (Max. Min.)	Jaw Stroke (diameter) mm	Plunger Stroke mm	Max. Gripping Force (at air pressure 0.6MPa (6.1kgf/cm ²)) kN (kgf)	Max. Speed min ⁻¹	Net Weight kg	Moment of inertia kg·m ²	Matching Soft top jaw	Max. pressure MPa	Air consumption per 10mm (at air pressure 6.1kgf/cm ²)	Serration pitch
UVE160K	38	170 18	8.4	24	45 (4588)	3600 (3500)	29.5	0.25	SB06C1	0.6 (6.1)	2.375	1.5
UVE200K	50	200 18	8.4	24	54 (5506)	3200 (2800)	38.5	0.35	SB10B1	0.6 (6.1)	2.990	1.5
UVE250K	60	250 18	9.8	28	90 (9177)	3000 (2200)	61	0.725	SB10B1	0.6 (6.1)	4.432	1.5
UVE315K	92	315 48	9.8	28	111 (11318)	2500 (1800)	81	1.45	SB12C1	0.6 (6.1)	6.343	1.5
UVE400K	120	400 90	14	40	210 (21413)	1800 (1200)	145	4.375	SB15A2	0.6 (6.1)	10.943	3

※Maximum speed is shown with each value under air pressure of 0.6MPa, using standard soft jaw and fixed air supply ring. If the supply ring is not fixed, each value in () is applied.

※Gripping force of a jaw is one third of max. gripping force.

※Standard accessories : Soft jaw, air pressure gauge, tools of a set.

Hard Jaw (Option accessories)

Model	Gripping range mm	Hard jaw
UVE160K	φ12~φ170	HBO6U1
UVE200K	φ14~φ180	HBO8U1
UVE250K	φ21~φ225	HBO8U1
UVE315K	φ36~φ310	HB12U1
UVE400K	φ80~φ400	HB16U2

※Hard jaw for UVE200K & 250K is same.

※Hard jaw for UVE500K size or more is manufactured under prearrangement.

Recommended air circuit diagram

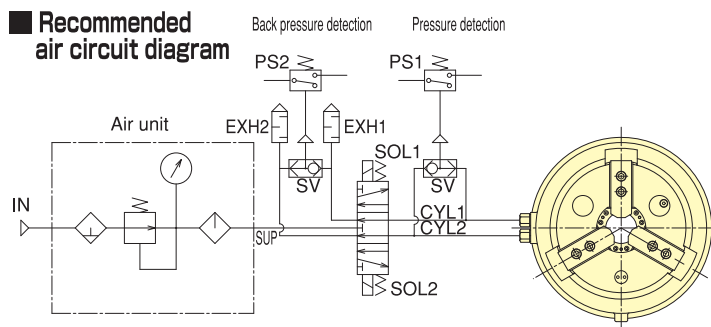



CHUCK

3-Jaw Air-Operated Self Contained Chuck UB series

Built-in Pneumatic Cylinder Large chuck best suited for pipe processing



Standard Chuck

- The jaw position can be detected
 - Internal pressure can be detected
- * CE correspondence

Dimensional Drawings

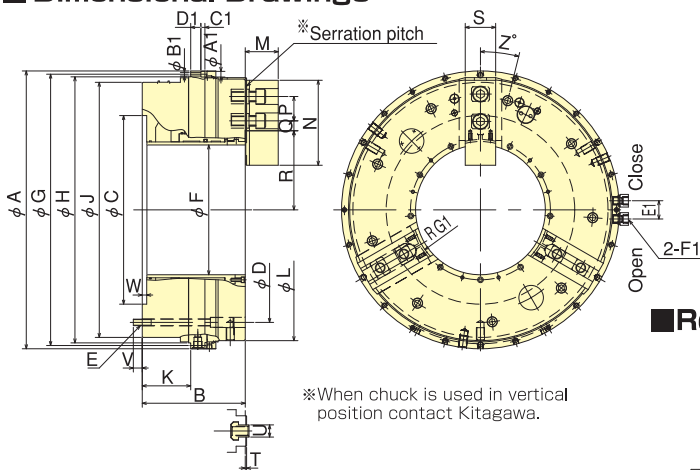

Recommended Air Circuit Diagram

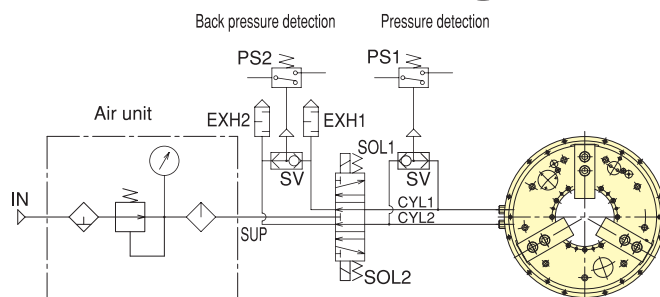

※ Serration pitch Model UBxxxK : mm, UBxxxP : inch

Dimensions

Model	A1	B1	C1	D1	E1	F1	G1
UB450K/P	11	6.6	6.6	25	45	Rc3/8	87.5
UB560K/P	14	9	9	20	45	Rc1/2	134
UB630K/P	14	9	10	25	45	Rc1/2	160
UB710K/P	17	11	11	33	45	Rc1/2	185

Model	A		B		C (H7)		D	E	F	G	H (H7)		J	K	L	M		N	P	Q max.	Q min.	R max.	R min.	S	T	U	V	W	Z
	mm	inch	mm	inch	mm	inch					mm	inch																	
UB450K/P	494	212	275	373	9-M12	181	481	470	431	98.5	441	67.3	68.7	165	43	41.5	17.5	121.4	114.4	62	3.3	25.5	17	6	20				
UB560K/P	626	230	375	485	6-M16	275	610	595	556	113.5	568	70.5	71.9	180	60	42	18	169	160.5	65	3.3	25.5	24	11	40				
UB630K/P	698	254	465	555	9-M16	320	682	669	629	119.5	645	81.3	82.7	209.5	60	50.5	23.5	195	186.5	75	3.3	30	22	11	14				
UB710K/P	790	252	520	620	9-M16	375	770	745	702	118.5	714	81.3	82.7	209.5	60	62.3	26.3	222.5	211.5	75	3.3	30	24	11	24				

Specifications

Model	Thru-Hole mm	Gripping range mm Max. Min.	Jaw Stroke (diameter) mm	Plunger Stroke mm	Max. Gripping Force kN (kgf)	Max. Speed min ⁻¹	Net Weight with Soft top jaws kg	Moment of inertia kg·m ²	Max pressure MPa (kgf/cm ²)	Air consumption per 10mm (at air pressure 0.6MPa (6.1kgf/cm ²))
UB450K/P	181	441 120	14	40	100 (10200)	1300	204	5.55	0.6 (6.1)	4.83
UB560K/P	275	568 220	17	37	120 (12230)	1100	320	15.8	0.6 (6.1)	7.17
UB630K/P	320	645 225	17	37	162 (16520)	1000	480	28.1	0.6 (6.1)	9.27
UB710K/P	375	714 275	22	36	144 (14680)	900	550	38.9	0.6 (6.1)	11.10

※ Maximum speed is shown with each value under air pressure of 0.6MPa, using standard soft jaw and fixed air supply ring. If the supply ring is not fixed, each value in () is applied.
 ※ Gripping force of a jaw is one third of max. gripping force. ※ Standard accessories : Soft jaw, air pressure gauge, tools of a set.
 ※ The work of diameter smaller than the above minimum gripping diameter can be gripped by using a collet pad (option).

AVF-3-FL type manual change valve (Special accessories)

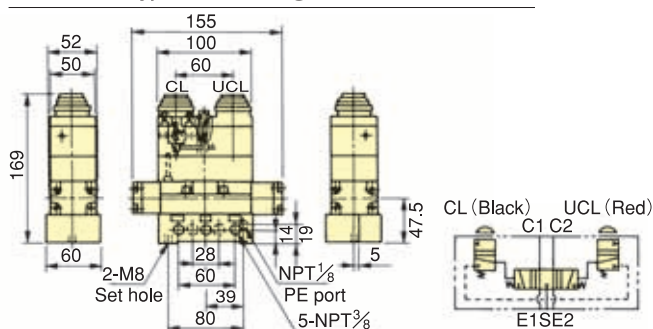

This valve is light-weight, compact and can be operated with the press of a button. The simple piping can be routed when the selector is mounted on the lathe. The valve is the exhaust centre type and designed for exclusive UB types.

Pressure	0~1MPa (10.1kgf/cm ²)
Proof pressure	1.5MPa (15.3kgf/cm ²)
Push button operation force	4kg
Connection bore	Rc3/8



CHUCK

3-Jaw Air-Operated Self Contained Chuck UPR series

Air-operated chuck perfect for oil pipe standards

- Easy installation
- Easy centering adjustment
- Service & maintenance improved.
Easy replacing consumable parts



Dimensional Drawings

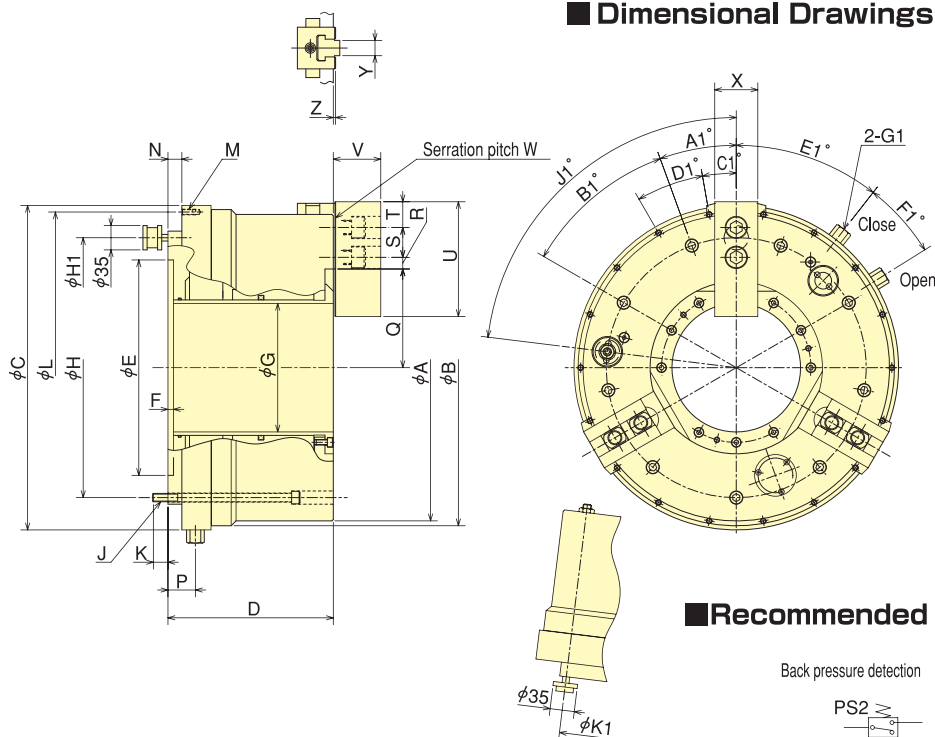

Recommended air circuit diagram

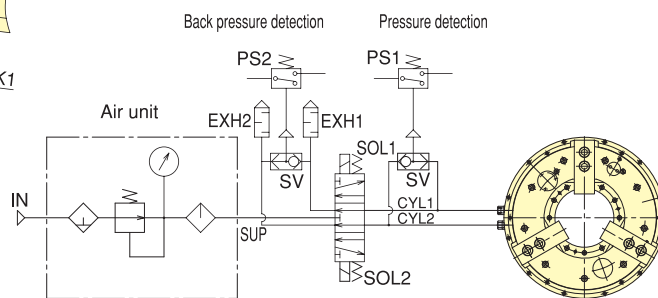

Dimensions

Model	A	B	C (0-0.2)	D	E (H7)	F	G	H	J	K	L
UPR450	441	455	467	238	310	8	185	374	9-M12	22	448
UPR600	590	605	605	272	450	8	275	508	12-M12	22	585
UPR650	655	675	685	283	510	8	325	580	12-M16	24	666
UPR710	715	740	750	283	550	8	375	620	9-M16	24	730
UPR910	915	915	925	291	700	10	560	800	12-M16	26	905

Model	M	N	P	Q max.	Q min.	R max.	R min.	S	T	U	V	W	X	Y (h8)	Z	A1	B1	C1	D1	E1	F1	G1	H1	J1	K1
UPR450	18-M8 Depth 20	20	39.5	142	122	34.75	16.75	43	37	165	68.3	1.5	62	22	3.3	20°	9x40°	10°	18x20°	38°	20°	Rc3/8	374	83°	374
UPR600	18-M8 Depth 20	20	50	196.5	171.5	32.5	20.5	60	39.5	180	70.5	3	65	25.5	3.3	15°	12x30°	0°	18x20°	25°	20°	Rc3/8	508	60°	508
UPR650	18-M8 Depth 20	20	50	223	198	38.5	20.5	60	40	209.5	81.3	3	75	30	3.3	15°	12x30°	0°	18x20°	25°	20°	Rc1/2	580	60°	580
UPR710	18-M8 Depth 20	20	43	248	223	50.5	23.5	60	40	209.5	81.3	3	75	30	3.3	20°	9x40°	0°	18x20°	30°	15°	Rc1/2	620	45°	620
UPR910	18-M8 Depth 20	33	56	342	317	50.5	23.5	60	40	209.5	81.3	3	75	30	3.3	15°	12x30°	0°	18x20°	30°	15°	Rc1/2	800	60°	800

Specifications

Model	Thru-Hole mm	Gripping range mm		Jaw Stroke (diameter) mm		Plunger Stroke mm	Max. Gripping Force kN (kgf)	Max. Speed min ⁻¹	Net Weight kg	Moment of inertia kg·m ²	Max. pressure MPa
		Max.	Min.	Rapid	Gripping						
UPR450	185	441	127	26	14	53	100(10197)	1300	195	5.5	0.6
UPR600	275	590	235	33	17	53.5	120(12236)	1100	365	19.7	0.5
UPR650	325	655	240	33	17	53.5	147(14990)	1000	476	32.2	0.6
UPR710	375	715	294	33	17	53.5	162(16519)	900	532	43.1	0.6
UPR910	560	915	475	33	17	53.5	162(16519)	600	735	103	0.5



CHUCK

3-Jaw Ultra High Precision Air Chuck KPC series

High Repeatability

Optimum KPC chuck for finishing and precision processes



● Built-in Pneumatic Cylinder

Dimensional Drawings

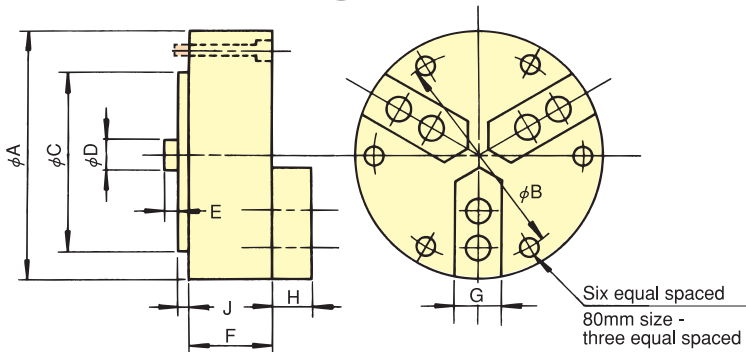

Gripping Characteristic Graphs

※ Each curve shows air pressure 0.7MPa (7.1kgf/cm²). This is a case that standard soft jaws are used.

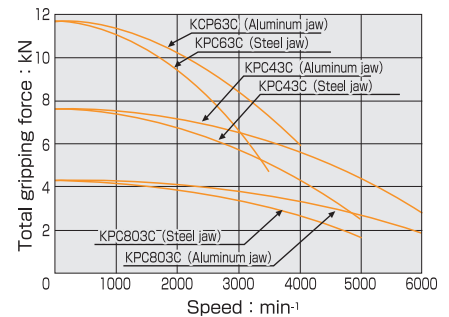

Dimensions

Dimensions model	A	B	C (h6)	D	E max.	E min.	F	G	H	J	Jaw Mounting bolts	Mounting bolts	Net Weight with Soft top jaws kg
KPC803C100	80	70	60	20.6	17	9.9	55	20	19	2	3-M5×16	3-M5×60	1.8
KPC43C048	100	88.9	82.55	20.6	18.8	15.3	50.5	20	19	2	3×2-M5×16	6-M5×55	2.1
KPC43C100	100	88.9	82.55	20.6	18	10.8	55	20	19	2	3×2-M5×16	6-M5×60	2.1
KPC63C100	150	135.8	124.97	20.6	17.6	10.4	56	25	19	2	3×4-M5×16	6-M6×65	6.3

Specifications

model	Specifications	Repeatability mm	Number of Jaws	Jaw Stroke (diameter) mm	Gripping range		Max. Gripping Force kN (kgf) (Air pressure 0.7MPa)	Max. Speed (with std. Aluminum jaw) min ⁻¹
					external φ	Internal φ		
KPC803C100P		0.0025	3	2.5	3~70	6~79	4.3 (438)	6000
KPC803C100EP		0.0013						
KPC803C100EP1		0.0010						
KPC43C048P		0.0025	3	1.2	3.5~87	6~99	7.6 (775)	6000
KPC43C048EP		0.0013						
KPC43C048EP1		0.0010						
KPC43C100P		0.0025	3	2.5	3~87	6~99	7.6 (775)	6000
KPC43C100EP		0.0013						
KPC43C100EP1		0.0010						
KPC63C100P		0.0025	3	2.5	3~135	6~149	11.6 (1183)	4000
KPC63C100EP		0.0013						
KPC63C100EP1		0.0010						

Ordering length of air feed tube (option)

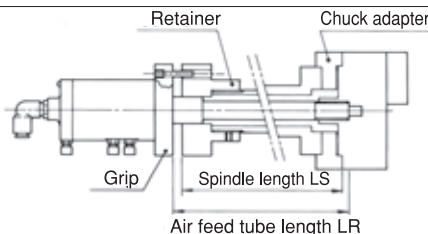

When ordering the air feed tube (coolant or non-coolant type), specify the spindle length LS as shown in the illustration. Air feed tube length LR is determined by LS. E.G. LR = LS + 17

In case of KPC43C048: LR = LS + 12
Chuck Adaptor and Retainer are options

Standard type jaw

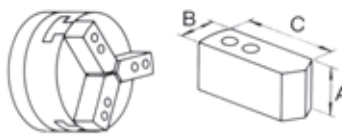

Pie type jaw



Standard type jaw Dimensions

Chuck	Jaw model	Mat-erial	Dimensions mm		
			A	B	C
KPC80 TYPE	KJ1A3-7	A l	19	20	38.4
	KJ1A3-15	A l	38	20	38.4
	KJ1A3-1	A l	25	20	38.4
	KJ1S3-7	S45C	19	20	38.4
	KJ1S3-15	S45C	38	20	38.4
KPC4 TYPE	KJ1A4-1	A l	25	20	48.4
	KJ1A4-7	A l	19	20	48.4
	KJ1A4-15	A l	38	20	48.4
	KJ1S4-1	S45C	25	20	48.4
	KJ1S4-2	S45C	51	20	48.4
KPC6 TYPE	KJ1S6-7	S45C	19	25	73.4
	KJ1S6-15	S45C	38	25	73.4
	KJ1S6-1	S45C	25	25	73.4

Pie type jaw Dimensions

Chuck	Jaw model	Mat-erial	Dimensions mm	
			A	D
KPC80 TYPE	KJ3A3-1	A l	25	80
	KJ3S3-1	S45C	25	80
	KJ3S3-7	S45C	19	80
KPC4 TYPE	KJ3A4-1	A l	25	100
	KJ3A4-15	A l	38	100
	KJ3S4-2	S45C	51	100
	KJ3S4-7	S45C	19	100
	KJ3S4-15	S45C	38	100
KPC6 TYPE	KJ3S6-1	A l	25	150
	KJ3S6-7	S45C	25	150
	KJ3S6-15	S45C	38	150